

D A R R A N

Conferencing

price list | effective January 2016 | updated 1.19.17



DATE	PAGE	MODIFICATION	DESCRIPTION
7.20.16	ALL	Removed Finishes	Removed discontinued finishes WGA, WTA, WWA, GRC, MGS
7.20.16	ALL	Added Finishes	Added new finishes MST Studio Teak and GST Studio Teak
8.29.16	N/A	Edited Table Base Matrix	Edited SKU TBB3535PB955 to TBB3131PB955
8.30.16	43	Edited Prices	Prices have been corrected
9.2.16	85	Updated SKUs	RE400W SKUs updated to RE500W
12.8.16	84	Added DT089	Added Round Conference Table with Column
12.12.16	75	Pricing Updated	Updated Pricing to Align with Prado Product
12.16.16	52	Dimension, SKU update	Updated dimensions and SKUs for the following: CAP7036WH573 to CAP7136OH573; CAP6436WH573 to CAP6536OH573; CAP5836WH573 to CAP5936OH573; CAP4736WH573 to CAP4836OH573; CAP3536WH573 to CAP3636OH573.
12.16.16	76	Dimension, SKU update	Updated dimensions and SKUs for the following: PRA7038WH573 to PRA6537OH573; PRA6438WH573 to PRA6537OH573; PRA5838WH573 to PRA5937OH573; PRA4738WH573 to PRA4837OH573; PRA3538WH573 to PRA3637OH573

TABLE OF CONTENTS

Product index 2

General Information 5

Limited Lifetime Warranty 6

Damages | Returns | Repairs 7

Ordering Information 8

GSA Customer Information 9

Freight..... 10

Features & Advantages 11

Finishes | Specifications 13

Edges | Pulls | Knobs 14

Grommets | Grommet Reference..... 15

Ganging | Height Reference 16

Drawer Dimensions | Filing Reference 17

Tables 18

Drum Bases 25

Cube Bases 29

Modesty Trough 38

Panel Pedestal Bases 41

Traditional Bases 43

Metal Bases..... 44

Conferencing Legs..... 49

Capitol Park Conferencing..... 50

Central Park Conferencing 55

Jamestown Conferencing 62

Not So Square Conferencing 68

Prado Conferencing 74

Richmond Park Conferencing..... 79

Rift Conferencing 85

Spaces Conferencing 93

Table Base Matrix 98

Options 102

Power and Data..... 125

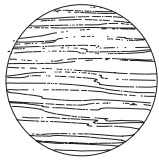

PAGE 18
TABLES

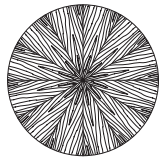

PAGE 19
TABLES



PAGE 20
TABLES

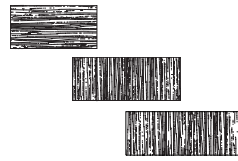

PAGE 21
TABLES

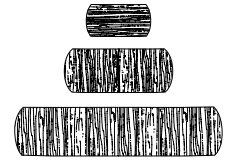

PAGE 22
TABLES

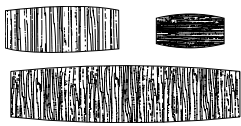

PAGE 23
TABLES

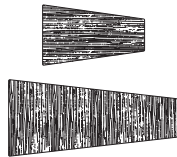

PAGE 24
TELECOM TABLES



PAGE 25
DRUM BASES

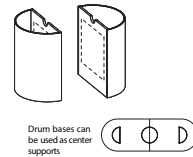

PAGE 26
DRUM BASES

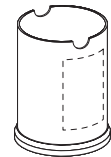

PAGE 27
DRUM BASES

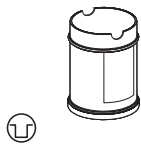

PAGE 28
TRADITIONAL DRUM BASES

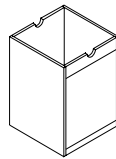

PAGE 29
CUBE BASES

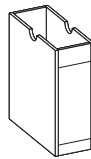

PAGE 30
CUBE BASES

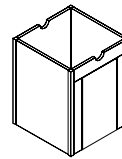

PAGE 31
CUBE BASES

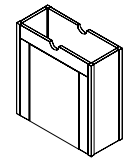

PAGE 32
CUBE POST BASES

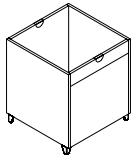

PAGE 33
CUBE BASES

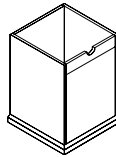

PAGE 34
CUBE BASES

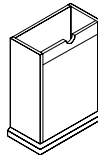

PAGE 35
CUBE BASES

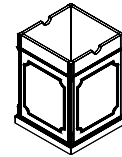

PAGE 36
TRADITIONAL CUBE BASES

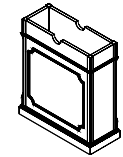

PAGE 37
TRADITIONAL CUBE BASES

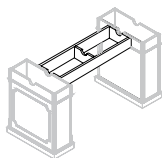

PAGE 38
MODESTY TROUGH / TRAY BASES

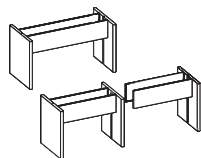

PAGE 39
PANEL BASE W/ WIRE
MANAGEMENT MODESTY

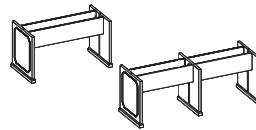

PAGE 40
PANEL BASE W/ WIRE
MANAGEMENT MODESTY

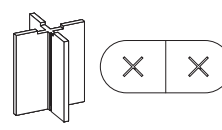

PAGE 41
PANEL PEDESTAL BASES

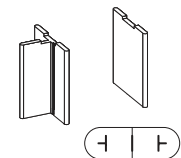

PAGE 42
PANEL PEDESTAL BASES

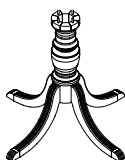

PAGE 43
TRADITIONAL BASES

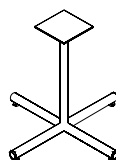

PAGE 44
METAL BASES

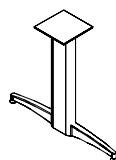

PAGE 45
METAL BASES

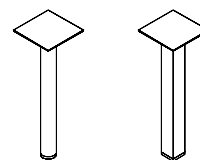

PAGE 46
METAL BASES

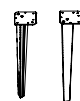

PAGE 47
METAL BASES

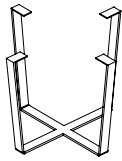

PAGE 48
METAL BASES

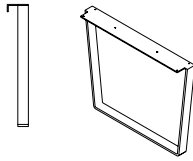

PAGE 49
CONFERRING LEGS

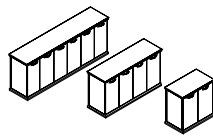

PAGE 50
FULL PEDESTAL CREDENZAS

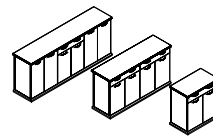

PAGE 51
FULL PEDESTAL CREDENZAS

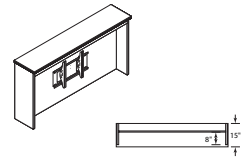

PAGE 52
OVERHEAD SUPPORTS



PAGE 53
VISUAL BOARDS

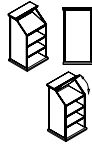

PAGE 54
LECTERNS

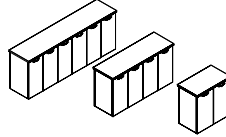

PAGE 55
FULL PEDESTAL CREDENZAS

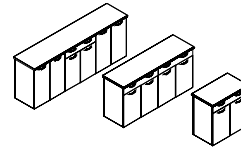

PAGE 56
FULL PEDESTAL CREDENZAS

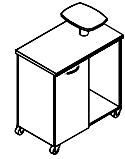

PAGE 57
CONFERRING CASEGOODS

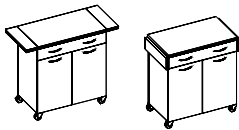

PAGE 58
CONFERRING CASEGOODS

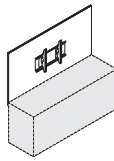

PAGE 59
WALL HUNG PANELS

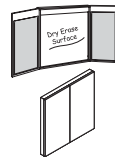

PAGE 60
VISUAL BOARDS

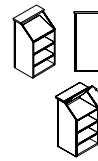

PAGE 61
LECTERNS

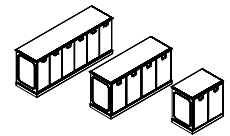

PAGE 62
FULL PEDESTAL CREDENZAS

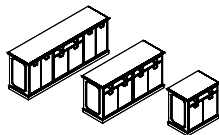

PAGE 63
FULL PEDESTAL CREDENZAS

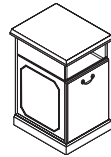

PAGE 64
CABINETS

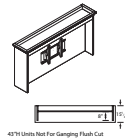

PAGE 65
OVERHEAD SUPPORTS

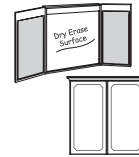

PAGE 66
VISUAL BOARDS

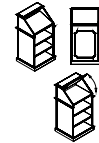

PAGE 67
LECTERNS

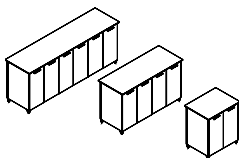

PAGE 68
FULL PEDESTAL CREDENZAS

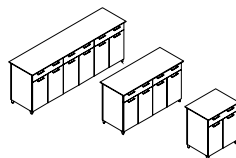

PAGE 69
STORAGE CREDENZAS

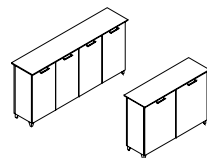

PAGE 70
STORAGE CREDENZAS

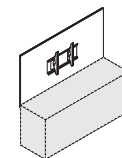

PAGE 71
WALL HUNG PANELS

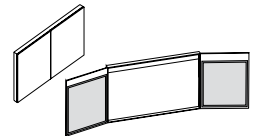

PAGE 72
VISUAL BOARDS

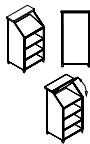

PAGE 73
LECTERNS

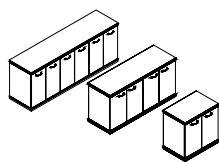

PAGE 74
FULL PEDESTAL CREDENZAS

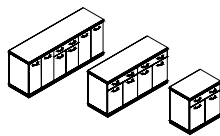

PAGE 75
FULL PEDESTAL CREDENZAS

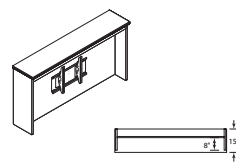

PAGE 76
OVERHEAD SUPPORTS

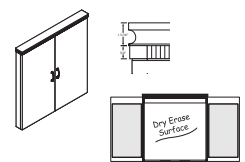

PAGE 77
VISUAL BOARDS

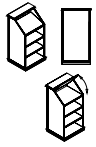

PAGE 78
LECTERNS

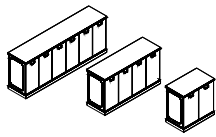

PAGE 79
FULL PEDESTAL CREDENZAS

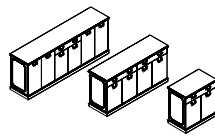

PAGE 80
FULL PEDESTAL CREDENZAS

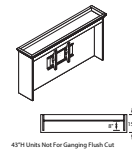

PAGE 81
OVERHEAD SUPPORTS

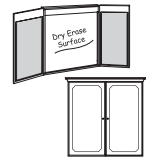

PAGE 82
VISUAL BOARDS

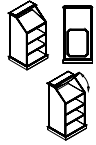

PAGE 83
LECTERNS

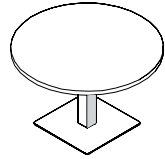

PAGE 84
CONFERENCE TABLE

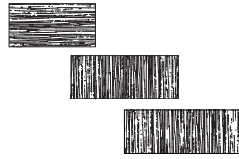

PAGE 85
TOP



PAGE 86
TOP

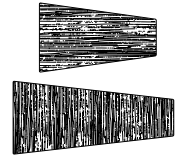

PAGE 87
TOP

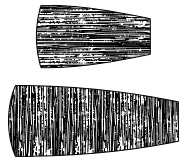

PAGE 88
TOP

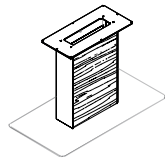

PAGE 89
BASES

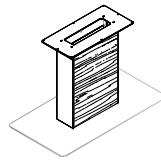

PAGE 90
BASES

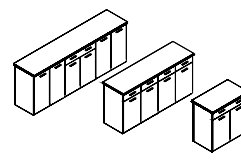

PAGE 91
CREDENZAS

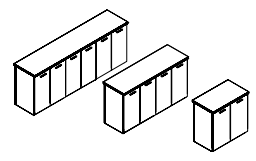

PAGE 92
CREDENZAS

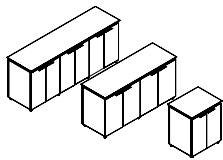

PAGE 93
FULL PEDESTAL CREDENZAS

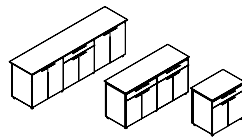

PAGE 94
FULL PEDESTAL CREDENZAS

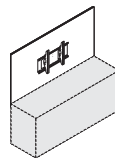

PAGE 95
WALL HUNG PANELS

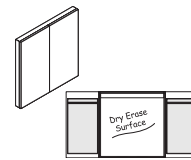

PAGE 96
VISUAL BOARDS

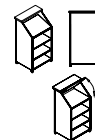

PAGE 97
LECTERNS



All DARRAN products are proudly manufactured in the U.S.A.

BUILT TO ORDER

Manufactured per order the way you want it, including modifications.

FULLY ASSEMBLED

Unless otherwise noted, all products are fully assembled and ready to use, including add-on options.

PERFORMANCE TESTED

All products are tested to ensure performance exceeds BIFMA / ANSI standards.



GREEN CERTIFIED

DARRAN has been committed to improving indoor air quality of office buildings since 1996. Since then, finish technology has allowed our commitment to continue with products that are air quality Certified Green.

DARRAN is proud to announce that all in veneer, laminate, and guest seating are MAS Certified Green for complying with the ANSI/BIFMA X 7.1 standard / LEED 4.5 Standard for low –VOC emitting Furniture.

MAS is an independent emission testing laboratory that is ISO 17025 compliant using ASTM, ANSI and CEN methods. MAS is a true 3rd party certification through NSF International to BIFMA standards and California’s ARB formaldehyde standard. Certification of compliance under the Low – VOC emitting Furniture testing, qualifies products for LEED 4.5 credits.



FINISH TECHNOLOGY

DARRAN has continued its partnership with AkzoNobel Chemicals (www.akzonobel.com) to develop a new finish technology further improving indoor air quality with a coating that meets today’s environmental standards and supports LEED buildings.

ENVI-CT (Environmental Coatings Technology) utilizes advanced European finish technology to deliver a high-end furniture coating with superior performance in appearance and durability, allowing DARRAN to deliver more sustainable products to our customers.

ENVI-CT Advantages:

- › ENVI-CT is a re-engineered high performance Top Coat
- › Exceptional hardness and clarity
- › Highly resistant to solvents and chemicals
- › Plasticizer Migration resistant
- › Excellent UV inhibitors for maximum color resistance
- › Exceeds current and proposed future Federal and State air quality requirements
- › Field Repairable
- › Dynamic chamber emissions tested and certified compliant to ANSI/BIFMA X 7.1 Standard / LEED 4.5 Standard for low – VOC emitting furniture.
- › Standard with Anti-microbial additive.

ADVANTAGES

DARRAN has upgraded the standard Anti-microbial protection, to , the latest in Silver Ion Technology. DARRAN collaborated with the world’s leader in finishing materials, to formulate an additive that will inhibit the growth of mold, mildew, fungus and bacteria on wood surfaces. This additive infuses Silver Ions into DARRAN’s ENVI-CT (Environmental Coatings Finish Technology), creating a protective surface for the life of the furniture. The best part - is standard on all DARRAN Casgoods for no additional fee.



LIMITED LIFETIME WARRANTY

DARRAN Furniture Industries, Inc. ("DARRAN") warrants that each piece of furniture manufactured in its North Carolina Facilities will be free from defects in material and workmanship for as long as the original purchaser owns and uses the product. Subject to the limitations and exclusions herein, DARRAN, at its discretion and as the sole remedy under the DARRAN Limited Lifetime Warranty, will replace or repair a defective product or components with comparable product or components free of charge. This warranty is made only to the original purchaser from an authorized DARRAN dealer, for as long as that original purchaser owns and uses the product.

LIMITATIONS: USE / CARE

- › Warranty is limited to normal single shift use.
- › Warranty is limited to generally accepted care and maintenance of natural wood products and environments.
- › Natural wood surfaces are subject to denting, scratching, and gauging if not properly used and cared for. Warranty is subject to use and care in accordance with the use and care instructions provided in the Product Care section of this site (including, but not limited to, the care and maintenance guide downloads linked thereon), available at www.darran.com/product care, which are incorporated herein by reference.

LIMITATIONS: MATERIALS / COMPONENTS

- › Laminates, Veneers / Finishes - 10 Years
- › Electrical lamps, Ballasts, Transformers - 5 Years
- › Fabrics, Pneumatic lifts, Foam - 5 Years
- › Custom products built to customers specifications - 3 Years

WARRANTY EXCLUSIONS

Damage identified as carrier or installer related.

- › Normal wear and tear of wood products during course of ownership.
- › Color, grain, or texture of natural wood materials, laminates, and other covering materials.
- › Damages or failures resulting from misuse, abuse, negligence, improper care, modifications, or relocation.
- › Non Commercial use or locations.
- › So-called "ghost" indentions and similar damage caused by the failure to use appropriate desk or writing pads.

All Warranty Claims are subject to DARRAN-approved inspections. Disputes may involve independent third-party evaluation

QUALITY ASSURANCE

DARRAN manufactures in accordance with the standards set by Architectural Woodwork Institute (AWI) for Quality Standards.

Every unit produced at DARRAN is completely inspected by an independent quality control team located within each plant whose emphasis is on assembly, finish, and final inspections with empowerment to stop any unit not meeting DARRAN's high quality standards.

LIGHT AND NATURAL FINISHES

The beauty of veneer and all wood products comes from the variations created by nature including color, grain, and texture.

These variations are not considered defects and DARRAN's Limited Lifetime Warranty does not cover color, grain and texture variations associated with natural wood and grain seen in any finish color. DARRAN sets standards for veneer selections; however, variations, especially apparent in light/natural finishes, will occur from one piece to another even if they are finished at the same time.

Finishes such as Clear Maple, Light/Gunstock Walnut, and Clear/Caramel Cherry will display more natural characteristics due to their light stain. Grain, pattern and color from unit to unit are not guaranteed or warranted and products will not be replaced due to these variations. Exposure to light and age will cause darkening of natural wood products; therefore DARRAN cannot guarantee or warrant finish match of new products being placed with existing products in the field.

GLASS

Use of glass overlays on surfaces will void DARRAN's Limited Lifetime Warranty, unless the overlay is installed and maintained in strict accordance with DARRAN's instructions. If an overlay is to be used, please contact DARRAN for installation and maintenance instructions.

GENERAL

Performance questions will be tested to generally accepted practices and AWI guidelines and standards for wood veneer furniture. To obtain performance of the Limited Lifetime Warranty, the purchaser should contact in writing the authorized DARRAN representatives or current dealer who sold the product to the purchaser or mail the warranty claim to:

Warranty Department
 DARRAN Furniture Industries, Inc.
 P.O. Box 7614
 High Point, NC 27264
 Telephone: 336-861-2400 Toll Free: 800-334-7891
 email: warranty@darran.com

EXCEPT FOR THE LIMITED LIFETIME WARRANTY EXPRESSLY DESCRIBED HEREIN, DARRAN MAKES NO OTHER REPRESENTATION OR WARRANTY OF ANY KIND, EXPRESS OR IMPLIED. DARRAN MAKES NO WARRANTY OF MERCHANTABILITY OR FITNESS FOR A PARTICULAR PURPOSE, AND DARRAN WILL NOT UNDER ANY CIRCUMSTANCES BE LIABLE FOR ANY INCIDENTAL OR CONSEQUENTIAL DAMAGES, OR ANY INDIRECT OR SPECIAL DAMAGES.

THE WARRANTY AS STATED ABOVE, SUPERSEDES ALL PREVIOUS WARRANTIES

NO HASSLE FREIGHT DAMAGED MERCHANDISE

DARRAN products are packed in specially designed cartons and padding that protects all edges and corners from damage. This is proven by an industry low damage rate of .0030% per total pieces shipped.

For qualified freight damage claims DARRAN will take responsibility for the claim and remedy processes including assuming total cost coverage from claim settlements.

(Some items may not qualify. Contact Factory for specific details.)

QUALIFIED CLAIM CONDITIONS**VISIBLE CARTON DAMAGE**

1. Take digital pictures of the damaged carton and damaged furniture if visible damage is found upon delivery at the dock
2. Open all cartons with puncture or crushed corner damage.
3. Note any damage to the goods on the Carrier's freight bill as number of pieces damaged.

CONCEALED DAMAGE

1. Take digital pictures of the furniture as it sits partially unpacked. Also, photograph external and internal carton materials that correspond with the damaged area on the product.
2. Carton and damaged unit(s) must be located at the location matching the original delivery address for Carrier inspection.
3. Digital pictures must be provided of the damaged furniture and carton materials

For qualified claims per above contact DARRAN Customer Service Department at 1-800-334-7891 or complete DARRAN's online warranty report form within the 15 day limit. www.darran.com/warrantyreport

NON-QUALIFIED CLAIM CONDITIONS

1. Deliveries made to non-dock locations
2. Claims made after furniture is installed and/or removed from original delivery location
3. Carton and padding has been discarded
4. Carrier used was not DARRAN approved
5. Inspection reveals questionable damages

REPLACEMENT ORDERS

Replacement orders entered without replacement tagging or factory authorization is considered a new order without dispute, therefore full payment is expected and will be collected.

RETURN SHIPMENTS

DARRAN will not accept return of merchandise without a signed RA (return authorization) form.

DARRAN will specify the carrier to be used. Return bills of lading must be marked "Class 125" freight rate and a copy of the RA should be used as a packing list. All returns must be received by DARRAN within 30 days of the RA date or the products will be considered accepted by the customer.

All products being returned must be properly packed and protected to avoid freight damage. Whenever possible, use the original cartons in which the merchandise was shipped. Freight

damage, signs of usage, missing parts, etc., will result in an adjustment of any credit to be issued.

DARRAN will issue RA's for the following reasons:

1. Manufacturing defect (inspection required)
2. Order processing error by DARRAN
3. Shipping error
4. Mismarked carton / merchandise

SPECIFICATION CHANGES

We reserve the right to change without notice any dimension, style, or specification of any model in the DARRAN line. Dimensions shown in the price list are nominal. It is the buyer's responsibility to read specification carefully when matching existing goods is desired.

MANUFACTURING DEFECTS

Claims of manufacturing defects will not be entertained without prior consultation with DARRAN's warranty department. Unauthorized deduction in payment of invoices will not be allowed without prior factory approval. Unapproved deductions are subject to factor's late payment charges.

DAMAGE CLAIMS

Claims of manufacturing damage or freight damage reported as nicks, dents, scratches, etc. after installation of furniture will not be covered under warranty or freight claim.

ATTENTION: Damage claims involving glass or stone components must be inspected and damage noted on delivering freight bill to qualify for replacement.

REPAIR CHARGES

Factory authorization must be secured from DARRAN's warranty department prior to incurring repair charges. Warranty will utilize DARRAN's National Repair Service through the Furniture Medic Franchise (www.furnituremedic.com).

Repair charge authorizations are based on:

- › Set travel rate
- › Average regional job rate
- › Factory set maximum repair time
- › Falsely reported defect claims are subject to local service charges being charged to dealer/distributor.

FINISH MAINTENANCE

Wood office furniture and wood finishes can retain their natural beauty for life if proper care is taken and a stable environment is provided. Fluctuations in humidity and temperature cause panels and solid wood components to expand and contract and may lead to panel warpage and finish "checking" or cracking. Prolonged exposure of furniture to dry heat during winter months should be avoided. Careful examination of interior wood trim may indicate a damaging dry environment. If open joints, splits and cracks are appearing in trimwork consult with a HVAC professional for appropriate remedy.

DARRAN finishes are field repairable should damage occur. Professional furniture repair services are recommended. Regular cleaning with a non-silicone polish is recommended.

ORDERING

All orders should be emailed, mailed or transmitted by fax to:

DARRAN Furniture Industries, Inc.
P.O. Box 7614
High Point, NC 27264
email: orders@darran.com
Fax: 336-861-6485

DARRAN will only accept orders from authorized Dealers. All orders must be accurate and detailed. All Quick Ship orders must contain Quick Ship product ONLY. Orders should be separated and submitted according to lead time. Orders must contain Quick Ship code "QS" or have designated Quick Ship lead time to ensure correct order entry. Orders that contain multiple lead time products will be entered as one order and scheduled with the most extended lead time.

CREDIT APPROVAL

All orders are subject to credit approval for open account. All new accounts must be approved by a local DARRAN Sales Representative and should submit current financial information and trade references to:

DARRAN Furniture Industries, Inc. ATTN: Credit Department
P.O. Box 7614
High Point, NC 27264
Telephone: 336-861-2400 Toll Free: 800-334-7891
Fax: 336-861-2512

Orders submitted without accounts pre-approval or credit approval are subject to acceptance with lead times scheduled only after approval dates.

LEAD TIME SCHEDULE

DARRAN cannot assign a firm lead time until Credit approval and order accuracy are complete. Extended lead times due to credit or information delays are the responsibility of the Buyer.

ORDER DELAY / HOLD

Due to the committed manufacturing cost on Quick Ship processes, DARRAN cannot delay or hold orders, either in process or after completion.

CANCELLATION AND ORDER CHANGES - FEES

Acknowledged orders are considered firm orders and therefore not subject to cancellation or change. However, in the event we are able to stop an order prior to manufacturing process, we will consider cancellation or changes with a reprocessing fee of \$40.00 Net. Exceptions: Quickship orders cannot be changed or canceled after the 3rd business date after acknowledgment. Qualified changes/cancellations will be assessed a \$40.00 Net processing fee.

Changes or cancellation of order with special options or custom quoted items are also subject to additional material and vendor fee costs, plus a DARRAN special/custom reprocessing fee of \$100 NET.

ORDER MOVEUPS

Should an original scheduled ship date need to be improved, the Factory must be contacted 15 business days prior to the desired ship date. Move ups are subject to schedule availability.

ORDER ACKNOWLEDGMENT

Upon credit approval your order will be acknowledged and identified by an order number. When making reference to your order, please use this order number. Your acknowledgment is a detailed description of our interpretation of your order, pricing, shipping information, and estimated delivery date.

If you have not received an Acknowledgment within 10 Days of order issue, contact Customer Service immediately. All Quick Ship order acknowledgments will be faxed or emailed upon request to speed processing. Please read your acknowledgment carefully for correctness and notify DARRAN immediately of any discrepancies. Failure to notify relieves DARRAN from error liability.

Order acknowledgment is the final agreement between DARRAN and the customer superseding all previous communications regarding the order. DARRAN will not be responsible for errors made on orders placed by phone without written confirmation.

SELLING INFORMATION

Possession of this price list does not in itself constitute the right to sell DARRAN products. DARRAN products are sold and distributed through authorized dealerships. Contact factory for a listing of local representatives and dealerships.

INVOICE TERMS

Standard terms are NET 30 days. Finance charges of 1-1/2% will be added to delinquent accounts after 45 Days and for each 30 Days thereafter until paid.

Complaints involving newly received merchandise must be reported within 10 days from receipt to qualify for full invoice remittance suspension or term extension. Otherwise only items in dispute can be suspended from payment of invoice within terms.

WAREHOUSE/STORAGE

DARRAN will determine order warehousing approvals on a case by case basis. Orders that can be accommodated will be limited to a max of 30 days storage and must be invoiced at time of storage. Orders that exceed factory storage capacity will be transferred to local storage facilities subject to current storage rates and handling-transit charges. Storage charges must be paid prior to order release to shipping.

**EXECUTIVE OFFICE & CONFERENCE ROOM
FURNITURE**

November 3, 2015 through November 2, 2020

FSC Group 71

GSA CONTRACT NUMBER: GS-27F-001DA

Business Classification:

WBENC Certified Woman-Owned Small Business

DARRAN FURNITURE INDUSTRIES

2402 SHORE DRIVE

HIGH POINT, NC 27263

336.861.2400 FAX 336.861.6485

Business Classification:

Woman-Owned Small Business

On-line access to contract ordering information, terms and conditions, up-to-date pricing, and the option to create an electronic delivery order are available through GSA Advantage!, a menu driven database system. The INTERNET address for GSA Advantage is <http://www.fss.gsa.gov>

For more information on ordering from Federal Supply Schedules click on the FSS Schedules button at <http://www.fss.gsa.gov>

1a. Special Item Number

711-8: Executive Office Furniture

711-9: Executive Conference Room Furniture

711-11: Tables and Accessories

711-16: Upholstered Seating

711-18: Multi-purpose Seating

2. Maximum Order Limitations:

711-8 \$500,000

711-9 \$500,000

711-11 \$500,000

711-16 \$300,000

711-18 \$200,000

3. Minimum Order: \$100

4. Geographic Coverage: 48 Contiguous States and the District of Columbia

5. Point of Production: High Point, North Carolina (Randolph County)

6. Discount: Prices shown herein are List (Discount is 56.9% Off List)

7. Quantity Discounts:

• \$467,837 List to \$1,000,000 List = 59.70%

• \$1,000,001 List to \$1,315,789 List = 61.70%

8. Payment Terms: ½% - Net 15 Days, Net 30 Days

8a. Terms and Conditions of Government Credit Card Acceptance:

a. No discount allowed for payment by Government Purchase Card

b. Provide commercial credit card number

c. Provide commercial credit card expiration date

d. Provide individual's name as it appears on

credit card

e. Provide telephone number of individual to whom credit is issued

9a. Government Purchase Cards are accepted below the Micro Purchase Threshold.

9b. Government Purchase Cards are accepted above the Micro Purchase Threshold.

10. Foreign Terms: None

11a. Time of Delivery: Regular Product: 60 - 90 days after receipt of order

Quick Ship Program: Contact DARRAN

11b. Quick Ship Program: Items available for expedited delivery are included in main Price Lists.

11c. Overnight and 2-day delivery: N/A

11d. Urgent Requirements: Will be considered on an individual basis. Contact DARRAN for details.

12. FOB Point: All destinations are limited to Commercial docks only. Carriers may refuse non-dock deliveries.

12a. Freight Prices:

a. All prices shown are suggested list prices with freight included where indicated.

b. Freight allows delivery to one qualified destination.

c. Within the Continental USA, all orders above \$1,500 net are shipped FOB factory, freight prepaid and allowed. All orders less than \$1,500 net will be subject to a \$100 net freight charge.

13. Ordering Address:

DARRAN Furniture Industries

P.O. Box 7614

High Point, NC 27264

Ph: 800.334.7891

Fax: 336.861.6485

13a. Payment Address:

BB&T

P.O. Box 890011

Charlotte, NC 28289-0011

14. Warranty Provision: Limited Lifetime (Contact DARRAN for details)

15. Export Packing Charges: Quoted on request

13. Terms and Conditions: Order Cancellation / Changes.

Restocking/Returns: No merchandise may be returned without a return authorization and shipping instructions. No credit or allowance will be given for repairs to defective materials unless DARRAN has given authority to make such repairs. A restocking charge of 25% will apply.

Cancellation: No cost prior to production. After

GSA CUSTOMER INFORMATION

production has begun, only actual cost incurred will be billed to the Government that cannot be recovered through resale in 6 months

14. Terms and Condition of Rental, Maintenance and Repair: Consult the Factory.

15. Terms and Conditions of Installation: Installation by a Third party to be quoted on a per job basis. The ordering must specify what ranges of installation services are required.

16. Terms and Conditions of Repair Parts: Contact DARRAN for details.

17. List of Service and distribution points: Contact DARRAN for details..

18. Preventative Maintenance: Information enclosed with product.

19. List of Participating Dealers: Contact DARRAN for details.

23. Environmental Attributes: DARRAN is compliant with EPA standards. All plywood core material is CARB 2 compliant and contains recycled content. All DARRAN Casegood Products are BIFMA Level 2 Certified. DARRAN is FSC CoC Certified and our products are MAS Certified for Indoor Air Quality.

23a. Recyclable and Recycled Content Packaging: The corrugated packaging that is supplied to DARRAN, meets the federal mandate that requires the paperboard to be composed of 30%-50% recycled paper, and in some cases the recycled content is close to 100%.

23b. Chemical Emission: DARRAN finishes its products in an ENVI-CT Finish. (Environmental Coatings Technology). DARRAN's seating is finished with a low VOC Conversion Varnish and the casegoods are finished with a formaldehyde free, low VOC Urethane finish. These ENVI-CT finishes allow DARRAN's products to be MAS Certified Green under the ANSI BIFMA X7.1 Standard. Products assist with LEED 4.5 Credit.

23c. Vapor Emissions: DARRAN's ENVI-CT finishes use the latest environmental coatings technology to provide lasting durability and exceptional clarity with BACGUARD Silver anti-microbial protection built-in. The ENVI-CT finishes allows DARRAN casegoods to be MAS Certified Green meeting LEED Credit 4.5.

24a. Duns Number: 08-363-5318

24b. Cage Code: 0Y-6B6

24c. Federal ID Number: 56-117-1971

24d. NAICS Code: 337211

25. SAM Network: DARRAN is registered

SHIPPING SCHEDULE

When requested, DARRAN will assist in locating special express carriers that may have short transit times. These services may exceed our prepaid freight costs; therefore, pricing is limited to the Freight Excluded formula with special express charges added to the invoice.

For special deliveries, DARRAN will make every effort to meet the appointed time; however DARRAN will not be responsible for any additional charges for late deliveries beyond our control.

PRICES

- › All prices shown are suggested list prices with freight included where indicated.
- › Freight allows delivery to one qualified destination.
- › Within the Continental USA, all orders above \$1,500 net are shipped FOB factory, freight prepaid and allowed. All orders less than \$1,500 net will be subject to a \$100 net freight charge.

CALL BEFORE DELIVERY REQUEST

DARRAN will arrange for carriers to call before delivery when requested.

Important Non-Qualified Destinations DARRAN Prepaid Freight Pricing does not include delivery to:

- › Residential Areas
- › Restricted Commercial Areas
- › No Dock Locations
- › Inside delivery/setup service

Orders received and installed without professional Furniture Installers voids all Warranty Coverage.

CARRIER SELECTION

DARRAN selects and uses only carriers specialized in furniture transportation. Customer requested carriers can be authorized using Freight Excluded pricing with invoice add-on.

SPECIFIC DELIVERY TIMES

DARRAN will assist in coordinating a requested delivery time from a carrier. DARRAN makes no guarantees and accepts no responsibility for such services as DARRAN has no control over possible carrier hazards. To ensure specific time arrival, we recommend arranging single stop, designated load carriers. Less than trailer load (LTL) shipments cannot be coordinated for a guaranteed delivery time.

EXPRESS CARRIERS

When requested DARRAN will assist in locating special express carriers that may have short transit times. These services exceed our prepaid freight cost, therefore, pricing is limited to the Freight Excluded formula with special express charges added to invoice.

FEATURES & ADVANTAGES

VENEER AND HPL TOPS

Wood veneer tops and high-pressure laminate tops feature a M2 Grade, CARB2 MDF Core with balanced 3-ply construction. Tops are 1-5/16" thick on all veneer and HPL products except for the Rift Collection, which features 1-1/2" thick primary work surfaces. Tops are connected to chassis with steel angle brackets, wood cleats and dowels. DARRAN only uses HPVA A Grade Flat Cut Cherry, Maple, and Walnut Veneers that are book-matched and slip-matched. Rift-Cut White Oak and Quarter-Cut Ash are available as premium veneers. DARRAN's Rift Collection features a double-cut veneer in a rift-cut pattern for a clean linear aesthetic. Veneer tops feature shapeable MDF edges, 3/4", 1", or 3mm external solid hardwood bands based on collection and edge selection. HPL tops feature a laminate self edge, shapeable MDF edge, or a 3mm solid wood edge based on edge selection.

TFL TOPS

Thermally Fused Laminate tops feature M2 Grade, CARB2 MDF Core with 3-ply balanced construction. Tops are 1-1/8" thick and feature a 2mm flat PVC edge band providing high impact durability. Tops are connected to chassis with steel angle brackets and dowels.

CHASSIS & PEDESTAL CONSTRUCTION

All pedestals and chassis are constructed with 3/4" thick balanced 3-ply panels. Panels are securely fastened together using rails that are bored and doweled, glued, metal reinforcement brackets and wood cleat construction. Thick end panels are pre-bored to accept a tee nut for the adjustable glide and are reinforced with pvc banding to prevent glide tear out. Glue blocks are used where 3/4" thick panels are joined, bored for tee nut to accept adjustable glide.

OVERHEAD CABINET CONSTRUCTION

(FREESTANDING AND WALL MOUNT)

Freestanding Overhead storage cabinets are constructed of 1" and 3/4" thick balanced 3-ply panels. Panels are attached with cam fasteners in conjunction with dowels securely adhered with PVAc (white polyvinyl acetate) glue. All surface mount cabinets connect to work surface with anti-slip tape. Wall mount cabinets are mounted to the wall with steel cabinet hangers with vertical adjustment to attach to the back of the cabinet. All units ship with a steel "z" bracket. This bracket is mounted to the wall by field installers. Installers are responsible for selecting and supplying appropriate fasteners for wall conditions.

BOOKCASE CONSTRUCTION

All chassis (sides, back, top and bottom panels) are constructed with 3/4" thick balanced 3-ply panels. Panels are attached with cam fasteners in conjunction with dowels securely adhered with PVAc (white polyvinyl acetate) glue. Shelves on all units are 3/4" thick balance 3 ply panels. Optional heavy duty shelves are 1" thick lumber core balanced 5 ply construction.

TACKBOARDS

Wall mount tackboards are constructed of .75" thick fiberboard.

The fabric is precisely aligned and fitted to the tackboard with a sock on cover.

Overhead storage tackboards are constructed of .5" thick fiberboard. The fabric is precisely aligned and fitted to the tackboard and adhered to the rigid hardboard with staples.

ADJUSTABLE GLIDES

Glides provide 1" of vertical leveling adjustment. Glide bottom is durable metal.

DRAWERS

All drawers are constructed of four sides and a bottom, which are attached to a drawer front with screws for easy removal. Drawer fronts feature vertically matched veneer within each pedestal. Pencil trays are standard in all box drawers. Jamestown, Prado, Rift, and Spaces feature maple veneer 1/2" thick material for drawer sides, fronts and backs with a UV finish for maximum durability. Drawer bottoms are 7/32" thick 3-ply maple veneer. Drawer boxes are assemble at each corner with dowel joinery for maximum drawer strength. Capitol Park, Central Park, NSsq, Reception Park, and Richmond Park feature drawers that are 1/2" thick wood grained wrapped 5 sided miter-folded construction with 1/8" thick hardboard bottoms.

SUSPENSIONS

All casegoods utilize cold rolled steel zinc plated high-grade drawer suspensions. All suspensions are warranted for the lifetime of the product. Box and File drawers are full extension, featuring steel ball bearings for a smoother quieter range of motion with soft close operation and are rated 100lbs. Lateral file drawers are a progressive action full extension suspension with the soft close operation and is rated at 150lbs. Lateral files include anti tip mechanism that will allow only one drawer at a time to be opened.

HINGES

Units with doors include 95 degree swing hinges.

FILING

Capitol Park, Central Park, NSsq, Reception Park, and Richmond Park feature a highly durable black plastic extrusion that is securely fastened into a route on top of the drawer.

Desk drawers are provided with a cross bar that allows for adjustability for letter or legal filing side to side, letter width filing front to back without the use of a cross bar. Credenza and Return filing is letter width front to back and legal width side to side without the use of a cross bar, letter width side to side with the use of a cross bar. Lateral files feature legal with filing side to side and two rows of letter width front to back with the use of cross bars.

Jamestown, Prado, Rift, and Spaces feature metal file frames around the perimeter of the drawers with cross bars. Desk drawers are provided with a cross bar that allows for adjustability for letter or legal filing side to side, letter width filing front to back without the use of a cross bar. . Legal width drawers are specified on desks 72" and larger, and filing is legal front to back or two rows letter side to side. Credenza and Return filing is letter width front to back and legal width side to side without the use of a cross bar, letter width side to side with the use of a cross bar. Lateral files feature legal with filing

side to side and two rows of letter width front to back with the use of cross bars.

LOCKS

Silver, black or bronze face locks are standard on all desks, credenzas, returns, and modular pedestals and match the color of the pull selection. Locks are optional on door storage, overhead storage, towers with doors and all door units. Each drawer pedestal is independently locked. Lock plugs are factory or field installed.

KEYING

Keying is available either factory or field installed. Factory installed keying is random.

WIRE MANAGEMENT

Wire management capabilities include standard and optional worksurface grommets. When grommets are standard or specified in a unit, wire channels under the surface are provided for organization and management of all communication wires and cords.

GROMMETS

Metal grommets are provided to match the drawer pull selection. Grommet is available in black, silver, white or antique brass. Must specify standard or non-standard location. Black plastic grommets are available as an option for vertical applications.

POWERPORTS

A large selection of powerports are available and handle power, data, docking stations and communication. See options section for selection.

LED TASKLIGHTS

LED task lighting provides high efficiency, low energy lighting with long life. LED lights are encased in a silver aluminum alloy material with built in switch to turn the light on/off. Lights are factory installed.

Product specifications listed below:

- Diffuser creates a softer light and eliminates hot spots.
- Built in switch with dimmer control.
- 30w 12Vdc 120V (UL approved) power supply
- Can be "daisy chained" up to 30W
- 50,000 hour life

SIZE	VOLTAGE	WATTAGE	COLOR TEMP.	CRI
24" light	12Vdc	6.4	5000K	90
48" light	12Vdc	12.8	5000K	90
60" light	12Vdc	16	5000K	90

"W" VENEER	"G" LAMINATE HPL TOPS	"M" THERMALLY FUSED LAMINATE
<small>Veneer</small>	<small>HPL</small>	<small>TFL</small>
WAC Amber Cherry	GAC Amber Cherry	N/A
WRC Caramel Cherry	N/A	N/A
WIC Crimson Cherry	GIC Crimson Cherry	N/A
WEC Ebony Cherry	N/A	N/A
WHC Honey Cherry	GHC Honey Cherry	MCH Honey Cherry
WOC Koko Cherry	GOC Koko Cherry	MOC Koko Cherry
WSC Scotch Cherry	N/A	N/A
WAM Alabaster Maple	GAM Alabaster Maple	N/A
WCM Clear Maple	GCM Clear Maple	N/A
WWM Wheat Maple	GWM Wheat Maple	N/A
WBO Blush Oak	N/A	N/A
WMO Mocha Oak	N/A	N/A
WTO Toast Oak	N/A	N/A
WWO Wheat Oak	N/A	N/A
WEW Executive Walnut	GEW Executive Walnut	N/A
WRW Gray Luster Walnut	GRW Gray Luster Walnut	N/A
WGW Gunstock Walnut	N/A	MGW Gunstock Walnut
WJW Judicial Walnut	N/A	N/A
WNW Natural Walnut	GNW Natural Walnut	N/A
WTW Studio Teak Walnut	GTW Studio Teak Walnut	MTW Studio Teak Walnut
WWP Full Fill Designer White	GWL Designer White	MWL Designer White
*TBCO Baby's Cheek (Oak)	N/A	N/A
TBSW Brown Sugar (Walnut)	N/A	N/A
*TFSO Fifty Shades (Oak)	N/A	N/A
*TFBO Fun Blonde (Oak)	N/A	N/A
TFBW French Bordeaux (Walnut)	N/A	N/A
TLLW Luscious Lager (Walnut)	N/A	N/A
TMMW Mellow Mink	N/A	N/A
TOBW Organic Brown (Walnut)	N/A	N/A

HPL TOPS ON TFL PRODUCTS ADD 10% - AVAILABLE ON CASEGOODS WITH FLAT EDGE ONLY

Send 3x3 or larger finish chip for color match. Custom finish upcharge is 3% or \$250 Net (whichever is greater).

FINISH

ENVI-CT Green Certified European Technology Coatings Finish with Anti-microbial protection.

VENEER AND HPL TOPS

Wood veneer tops and high-pressure laminate tops feature a M2 Grade, CARB2 MDF Core with balanced 3-ply construction. Tops are 1-5/16" thick on all veneer and HPL products except for the Rift Collection, which features 1-1/2" thick primary worksurfaces. Tops are connected to chassis with steel angle brackets, wood cleats and dowels. DARRAN only uses HPVA A Grade Flat Cut Cherry, Maple, and Walnut Veneers that are book-matched and slip-matched. Rift-Cut White Oak and Quarter-Cut Ash are available as premium veneers. DARRAN's Rift Collection features a double-cut veneer in a rift-cut pattern for a clean linear aesthetic. Veneer tops feature shapeable MDF edges, 3/4", 1", or 3mm external solid hardwood bands based on collection and edge selection. HPL tops feature a laminate self edge, shapeable MDF edge, or a 3mm solid wood edge based on edge selection.

TFL TOPS

Thermally Fused Laminate tops feature M2 Grade, CARB2 MDF Core with 3-ply balanced construction. Tops are 1-1/8" thick and feature a 2mm flat PVC edge band providing high impact durability. Tops are connected to chassis with steel angle brackets and dowels.

CHASSIS

3/4" thick core, Medium Density Fiberboard (MDF) rated EPP/SCS/CARB-II material with 3 ply balanced construction. Pedestal and cabinets feature dowl construction reinforced with steel bracket plates, wood cleats, screws and glue. Exposed interiors feature finished veneer of same species as exterior faces. Panel molding standard on approach and end panels of all worksurface height units.

NOTE: All units are standard with 1" adjustable glides that allow for leveling of units.

DRAWER FRONTS

Drawer fronts are vertically matched in balanced sets. Doors feature vertical veneer bookmatched horizontally in sets of 2 / 4 and 6 doors.

All drawers and doors have traditional scallop profile edge shape. All tower fronts matched in vertical sets.

DRAWERS

Drawers feature mitre joint / dowel construction with a natural maple finish. All drawers extend 100% for full access on steel ball bearing slides with cushion in-out stops. Drawers have been tested and passed BIFMA 50,000 cycle test. File drawers feature 1/4" bottoms reinforced for heavy weight capacity. All drawers are guaranteed lifetime with free replacement warranty.

OPTIONAL WOOD DRAWERS

Optional hardwood veneer plywood drawers feature banded top and bottom edges for smoothness. Drawers are dowel joint construction with a UV cured finish over maple veneers, plus a lifetime free replacement guarantee. Wood drawers are standard in Jamestown and Spaces.

Optional Wood Drawer (Any Size) – Option Code P33...\$40 List Price Per Drawer

RANDOM LOCKS & KEYING (STANDARD)

Locks are standard on all storage units below the worksurface. Random lock cores are installed at the factory. Some units may be shipped with the same key number. Locks are Silver, Black or Bronze and match pull finish unless specified.

- SRK: Random Silver Random Key - n/c
- BRK: Random Black Random Key - n/c
- ZRK: Random Bronze Random Key - n/c

FIELD INSTALLED LOCKS & KEYING (OPTION)

Field installed lock option can be selected, each unit is shipped with an empty lock cylinder. A separate line item must be ordered to receive the numbered lock cores for field installation. Field installed locks are available at an additional charge of \$5 list per lock core. Specify Silver or Black Locks.

- SFK: Field Installed Silver Random Key - n/c
- BFK: Field Installed Black Random Key - n/c
- ZFK: Field Installed Bronze Random Key - n/c

"W" & "G" PREMIUM PROFILE

Hardwood Rim Band Species Same As Surface Veneer

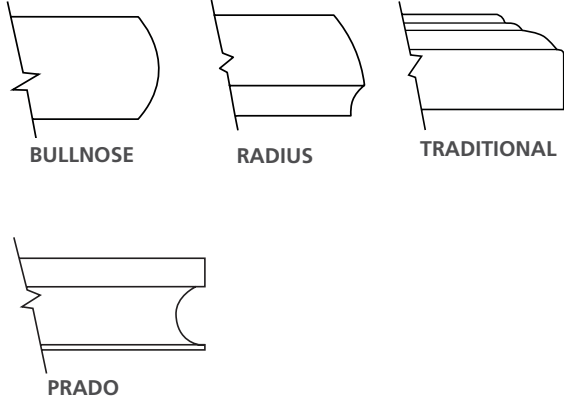

"W" & "G" STANDARD PROFILE

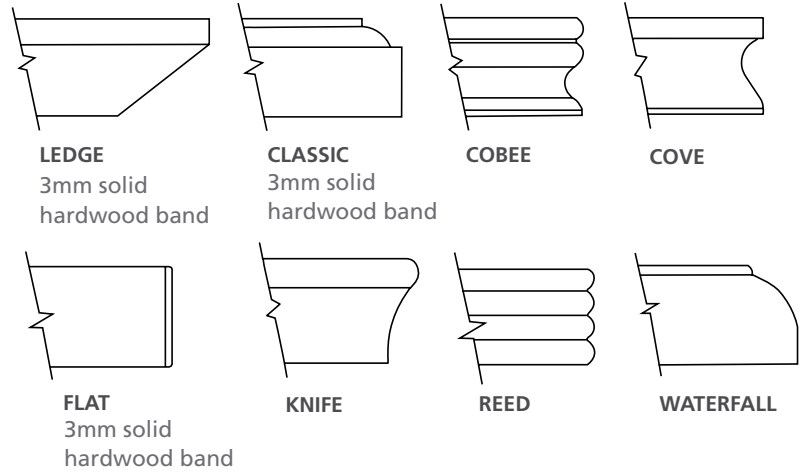

"M" STANDARD PROFILE
Central Park Edges for "M" Styles
1 mm PVC Edge with Black Foil

BEVEL
2 mm PVC Edge with Black Foil

CAPITOL PARK
2 mm PVC Edge with Black Foil

FLAT
2 mm PVC Edge



PULLS/KNOBS

Factory Installed

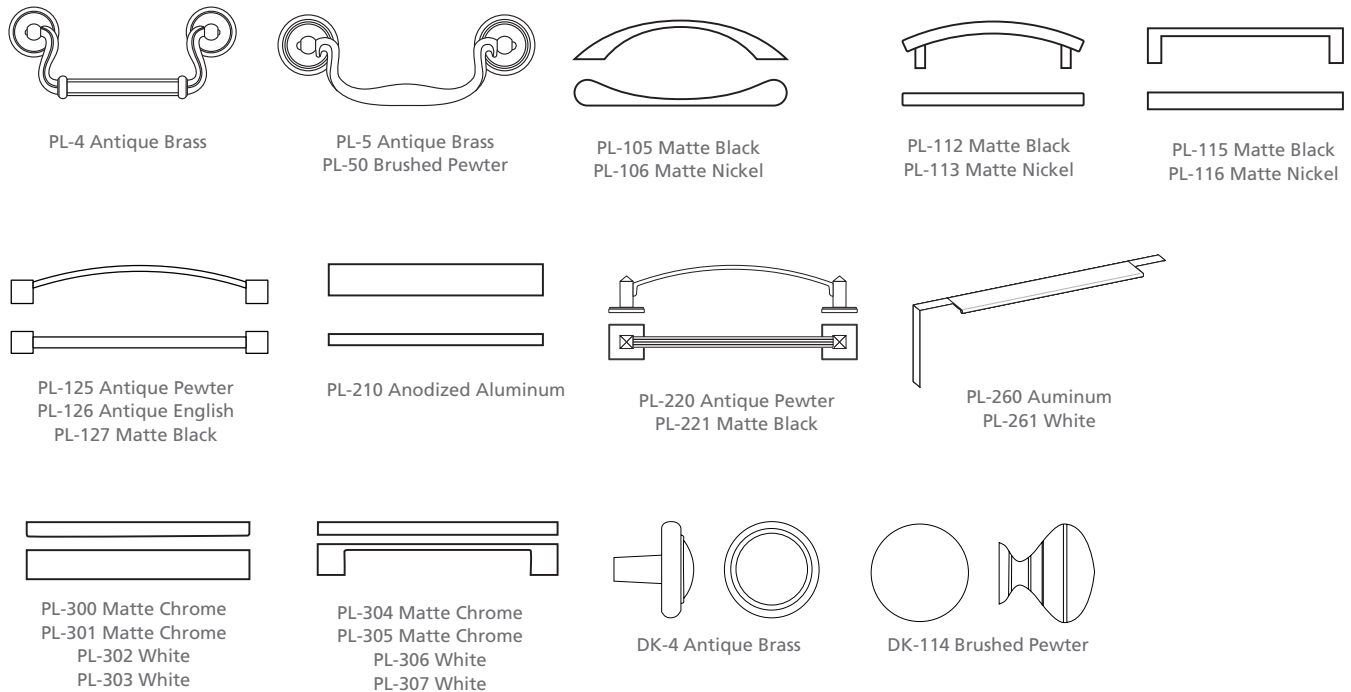

OPTIONAL WIRE MANAGEMENT GROMMETS

Factory Installed

When grommets are specified or standard in a unit, DARRAN provides wire channels under the surface for organization and management of all communication wires and cords.

Grommets (Standard Location)

Specify Color and Left/Right/Center - \$45 ea.

- Black: TM30-R (Right), TM30-L (Left), TM30-C (Center)
- Silver: TM31-R (Right), TM31-L (Left), TM31-C (Center)
- Antique Brass: TM33-R (Right), TM33-L (Left), TM33-C (Center)
- White: TM34-R (Right), TM34-L (Left), TM34-C (Center)

Grommets (Non-Standard Location)

Provide drawing w/ Grommet Location and Specify Color - \$90 ea.

- Black: TM30-NS
- Silver: TM31-NS
- Antique Brass: TM33-NS
- White: TM34-NS

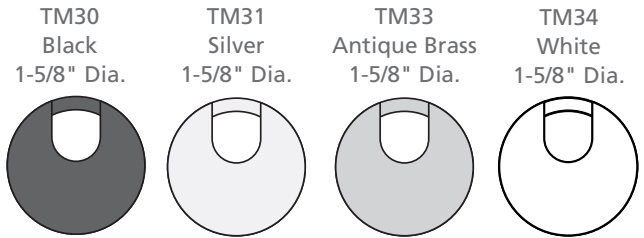

TM50
Black
1-5/8" Dia.



GROMMETS (VERTICAL SURFACE)

Standard Location - \$45 ea.

- Black Plastic Vertical Surface: TM50-C (Bottom Center)

Non-Standard Location - \$90 ea.

- Black Plastic Vertical Surface: TM50-NS

GANGING – FLUSH CUT MODIFICATION

30" H Casework Worksurface & Base Ganging Modifications

To gang two casework units, each unit end to be ganged must be flush cut modified for gapless surfaces and cabinet chassis.

Order Option:

- FC-B: Flush Unit Both Sides(Facing) for Ganging - \$95
- FC-L: Flush Unit Left (Facing) for Ganging - \$95
- FC-R: Flush Unit Right (Facing) for Ganging - \$95

Flush cut modification per unit includes all modifications to gang to one end or both ends when units are ganged. Modification includes tops, base and molding. Modification reduces width size approximately 1" per end.

Overhead consoles and towers are offered freestanding and ganging – inclusive of flush cut modifications.

Example:

RPC3121100W Two Drawer Lateral File (Left) Flush Cut Right – FC-R...\$95

RPC7221054 Kneespace Credenza (Right) Flush Cut Left – FC-L...\$95

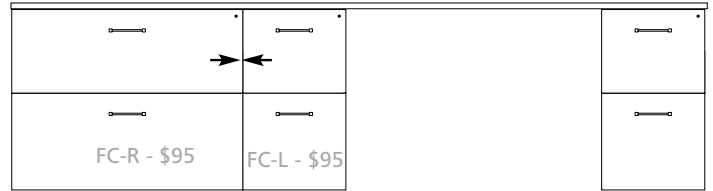

HEIGHT REFERENCE

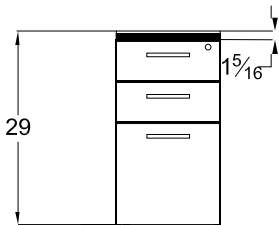

Pedestal Front Profile
Box/Box/File

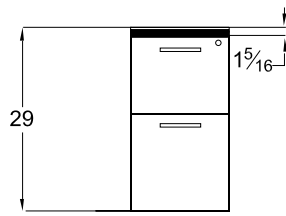

Pedestal Front Profile
File/File

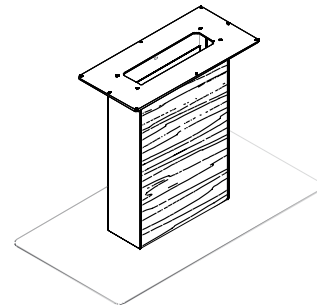

Height adjustable bases range from 29" to 49". Maximum weight capacity of 125 lbs.

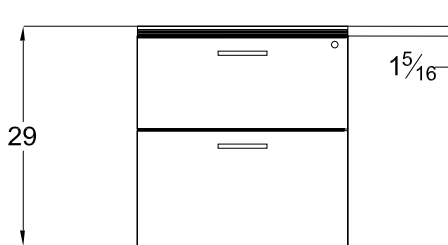

Pedestal Front Profile
Lateral File

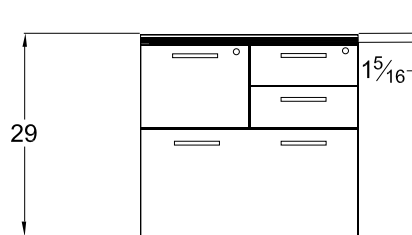

Pedestal Front Profile
Multi-File

INTERIOR DRAWER DIMENSIONS

UNIT DEPTH	DRAWER TYPE	OVERALL DIMENSIONS			INTERIOR DRAWER DIMENSIONS		
		W	D	H	W	D	H
29" Buffet	24" Box	26-1/2	16-1/16	4	25-1/2	15-1/16	3-7/16
35" Buffet	24" Box	32-1/2	16-1/16	4	31-1/2	15-1/16	3-7/16

FILING REFERENCE

FILING FOR 24" DEPTH UNITS

13" Wide File Drawer - 16" Deep

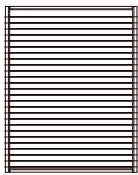

Letter Front to Back

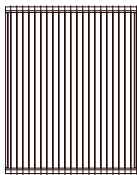

Legal Side to Side
with File Rail

FILING FOR 30" & 36" DEPTH UNITS

13" Wide File Drawer - 20" Deep

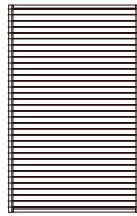

Letter Front to Back

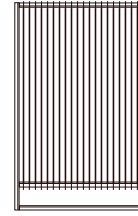

Legal Side to Side
with File Rail

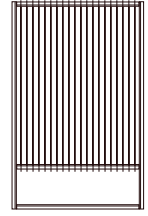

Letter Side to Side
with File Rail

29" LATERAL FILE DRAWER

26-1/2" Wide File Drawer - 16-1/16" Deep

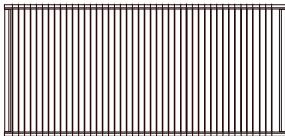

Legal Side to Side

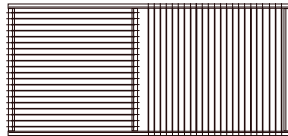

Legal Side to Side
Letter Front to Back
with File Rail

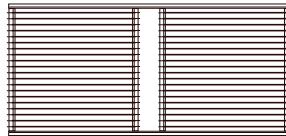

Letter Front to Back
with File Rail

35" LATERAL FILE DRAWER

32-1/2" Wide File Drawer - 16-1/16" Deep

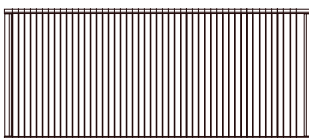

Legal Side to Side

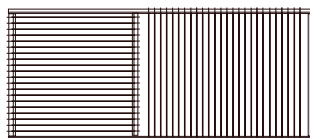

Legal Side to Side
Letter Front to Back
with File Rail

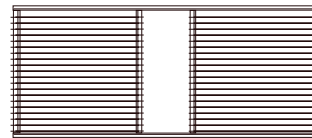

Letter Front to Back
with File Rail

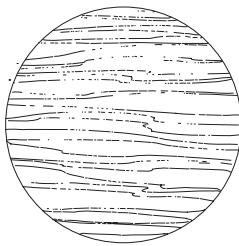

ROUND

STANDARD FEATURES

- 1.3125" thick
- BACGUARD SILVER anti-microbial protection
- ENVI-CT Finish *Environmental Coatings Technology

[CLICK HERE TO VIEW PRODUCT INDEX](#)

1 SELECT A STYLE

DIMENSIONS		STYLE NUMBER	LIST PRICE	STYLE NUMBER	LIST PRICE	STYLE NUMBER	LIST PRICE
W" x D" x H"	WGT	"W" Veneer Top		"G" High Pressure Laminate Top		"M" Thermally Fused Laminate Top	
		Veneer		HPL		TFL	
60 DIA	125	TBT6060RD500W	2380	TBT6060RD500G	2380	TBT6060RD500M	725
54 DIA	95	TBT5454RD500W	2105	TBT5454RD500G	2105	TBT5454RD500M	610
48 DIA	85	TBT4848RD500W	1690	TBT4848RD500G	1690	TBT4848RD500M	560
42 DIA	75	TBT4242RD500W	1440	TBT4242RD500G	1440	TBT4242RD500M	530
36 DIA	50	TBT3636RD500W	1260	TBT3636RD500G	1260	TBT3636RD500M	490

2 SELECT A FINISH

"W" Veneer	"G" HPL	"M" TFL	
WAC	GAC	-	Amber Cherry
WRC	-	-	Caramel Cherry
WIC	GIC	-	Crimson Cherry
WEC	-	-	Ebony Cherry
WHC	GHC	MHC	Honey Cherry
WOC	GOC	MOC	KoKo Cherry
WSC	-	-	Scotch Cherry
WAM	GAM	-	Alabaster Maple
WCM	GCM	-	Clear Maple
WWM	GWM	-	Wheat Maple
WBO	-	-	Blush Oak
WMO	-	-	Mocha Oak
WTO	-	-	Toast Oak
WWO	-	-	Wheat Oak
WEW	GEW	-	Executive Walnut
WRW	GRW	-	Gray Luster Walnut
GWG	-	MGW	Gunstock Walnut
WJW	-	-	Judicial Walnut
WNW	GNW	-	Natural Walnut
WTW	GTW	MTW	Studio Teak Walnut
WWP	GWL	MWL	Designer White

3 SELECT AN EDGE

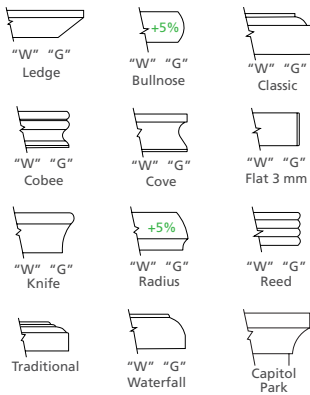

4 SELECT HARDWARE

Hardware Option Not Available

5 OPTIONS

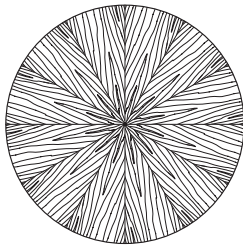

SUNBURST ROUND

STANDARD FEATURES

- 1.3125" thick
- BACGUARD SILVER anti-microbial protection
- ENVI-CT Finish *Environmental Coatings Technology

[CLICK HERE TO VIEW PRODUCT INDEX](#)

1 SELECT A STYLE

DIMENSIONS		STYLE NUMBER	LIST PRICE	STYLE NUMBER	LIST PRICE	STYLE NUMBER	LIST PRICE
W" x D" x H"	WGT	"W" Veneer Veneer Top Veneer Chassis		"G" HPL High Pressure Laminate Top Veneer Chassis		"M" TFL Thermally Fused Laminate Top Thermally Fused Laminate Chassis	
60 DIA	125	TBT6060SB500W	2893	"G" Option N/A		"M" Option N/A	
54 DIA	95	TBT5454SB500W	2010	"G" Option N/A		"M" Option N/A	
48 DIA	85	TBT4848SB500W	1960	"G" Option N/A		"M" Option N/A	
42 DIA	75	TBT4242SB500W	1730	"G" Option N/A		"M" Option N/A	

2 SELECT A FINISH

"W" Veneer	"G" HPL	"M" TFL	
WAC	-	-	Amber Cherry
WRC	-	-	Caramel Cherry
WIC	-	-	Crimson Cherry
WEC	-	-	Ebony Cherry
WHC	-	-	Honey Cherry
WOC	-	-	KoKo Cherry
WSC	-	-	Scotch Cherry
WAM	-	-	Alabaster Maple
WCM	-	-	Clear Maple
WWM	-	-	Wheat Maple
WBO	-	-	Blush Oak
WMO	-	-	Mocha Oak
WTO	-	-	Toast Oak
WWO	-	-	Wheat Oak
WEW	-	-	Executive Walnut
WRW	-	-	Gray Luster Walnut
WGW	-	-	Gunstock Walnut
WJW	-	-	Judicial Walnut
WNW	-	-	Natural Walnut
WTW	-	-	Studio Teak Walnut
WWP	-	-	Designer White

3 SELECT AN EDGE

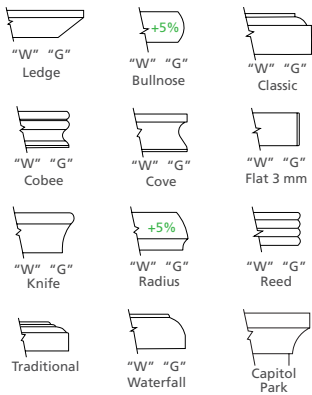

4 SELECT HARDWARE

Hardware Option Not Available

5 OPTIONS

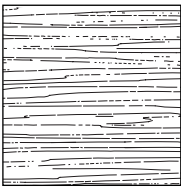

SQUARE

STANDARD FEATURES

- 1.3125" thick
- BACGUARD SILVER anti-microbial protection
- ENVI-CT Finish *Environmental Coatings Technology

[CLICK HERE TO VIEW PRODUCT INDEX](#)

1 SELECT A STYLE

DIMENSIONS		STYLE NUMBER	LIST PRICE	STYLE NUMBER	LIST PRICE	STYLE NUMBER	LIST PRICE
W" x D" x H"	WGT	"W" Veneer Veneer Top Veneer Chassis		"G" HPL High Pressure Laminate Top Veneer Chassis		"M" TFL Thermally Fused Laminate Top Thermally Fused Laminate Chassis	
60 x 60	125	TBT6060SQ500W	1901	TBT6060SQ500G	1901	TBT6060SQ500M	725
54 x 54	95	TBT5454SQ500W	1701	TBT5454SQ500G	1701	TBT5454SQ500M	610
48 x 48	85	TBT4848SQ500W	1355	TBT4848SQ500G	1355	TBT4848SQ500M	560
42 x 42	75	TBT4242SQ500W	1297	TBT4242SQ500G	1297	TBT4242SQ500M	530

2 SELECT A FINISH

"W" Veneer	"G" HPL	"M" TFL	
WAC	GAC	-	Amber Cherry
WRC	-	-	Caramel Cherry
WIC	GIC	-	Crimson Cherry
WEC	-	-	Ebony Cherry
WHC	GHC	MHC	Honey Cherry
WOC	GOC	MOC	KoKo Cherry
WSC	-	-	Scotch Cherry
WAM	GAM	-	Alabaster Maple
WCM	GCM	-	Clear Maple
WWM	GWM	-	Wheat Maple
WBO	-	-	Blush Oak
WMO	-	-	Mocha Oak
WTO	-	-	Toast Oak
WWO	-	-	Wheat Oak
WEW	GEW	-	Executive Walnut
WRW	GRW	-	Gray Luster Walnut
WGW	-	MGW	Gunstock Walnut
WJW	-	-	Judicial Walnut
WNW	GNW	-	Natural Walnut
WTW	GTW	MTW	Studio Teak Walnut
WWP	GWL	MWL	Designer White

3 SELECT AN EDGE

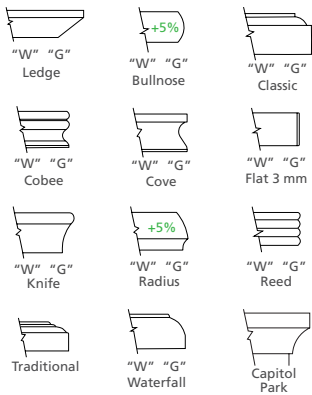

4 SELECT HARDWARE

Hardware Option Not Available

5 OPTIONS

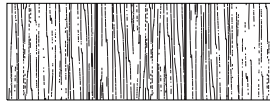
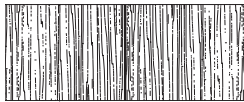

RECTANGLE

STANDARD FEATURES

- 1.3125" thick
- BACGUARD SILVER anti-microbial protection
- ENVI-CT Finish *Environmental Coatings Technology

[CLICK HERE TO VIEW PRODUCT INDEX](#)

1 SELECT A STYLE

DIMENSIONS		STYLE NUMBER		LIST PRICE		STYLE NUMBER		LIST PRICE		STYLE NUMBER		LIST PRICE	
W" x D" x H"	WGT	"W" Veneer Veneer Top Veneer Chassis		"G" HPL High Pressure Laminate Top Veneer Chassis		"M" TFL Thermally Fused Laminate Top Thermally Fused Laminate Chassis							
3 Piece Top													
240 x 60	615	TBT24060RE500W	7907	TBT24060RE500G	7907	TBT24060RE500M	2530						
240 x 54	555	TBT24054RE500W	7802	TBT24054RE500G	7802	TBT24054RE500M	2490						
2 Piece Top													
216 x 60	555	TBT21660RE500W	6720	TBT21660RE500G	6720	TBT21660RE500M	2150						
216 x 54	505	TBT21654RE500W	6636	TBT21654RE500G	6636	TBT21654RE500M	2120						
192 x 54	450	TBT19254RE500W	5266	TBT19254RE500G	5266	TBT19254RE500M	1620						
168 x 54	330	TBT16854RE500W	5124	TBT16854RE500G	5124	TBT16854RE500M	1575						
144 x 48	250	TBT14448RE500W	4673	TBT14448RE500G	4673	TBT14448RE500M	1435						
120 x 48	210	TBT12048RE500W	4370	TBT12048RE500G	4370	TBT12048RE500M	1410						
1 Piece Top													
96 x 48	170	TBT9648RE500W	2625	TBT9648RE500G	2625	TBT9648RE500M	850						
84 x 42	130	TBT8442RE500W	2536	TBT8442RE500G	2536	TBT8442RE500M	760						
72 x 36	100	TBT7236RE500W	2165	TBT7236RE500G	2165	TBT7236RE500M	675						

2 SELECT A FINISH

"W" Veneer	"G" HPL	"M" TFL	
WAC	GAC	-	Amber Cherry
WRC	-	-	Caramel Cherry
WIC	GIC	-	Crimson Cherry
WEC	-	-	Ebony Cherry
WHC	GHC	MHC	Honey Cherry
WOC	GOC	MOC	KoKo Cherry
WSC	-	-	Scotch Cherry
WAM	GAM	-	Alabaster Maple
WCM	GCM	-	Clear Maple
WWM	GWM	-	Wheat Maple
WBO	-	-	Blush Oak
WMO	-	-	Mocha Oak
WTO	-	-	Toast Oak
WWO	-	-	Wheat Oak
WEW	GEW	-	Executive Walnut
WRW	GRW	-	Gray Luster Walnut
WGW	-	MGW	Gunstock Walnut
WJW	-	-	Judicial Walnut
WNW	GNW	-	Natural Walnut
WTW	GTW	MTW	Studio Teak Walnut
WWP	GWL	MWL	Designer White

3 SELECT AN EDGE

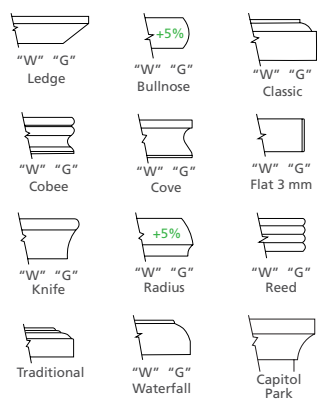

4 SELECT HARDWARE

Hardware Option Not Available

5 OPTIONS

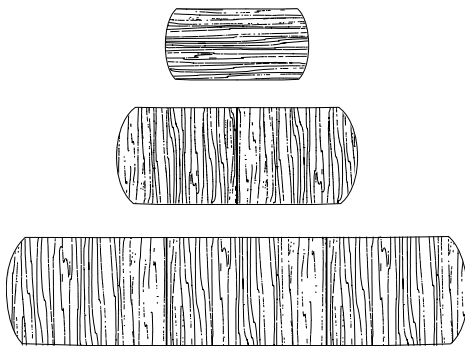

ARC END

STANDARD FEATURES

- 1.3125" thick
- BACGUARD SILVER anti-microbial protection
- ENVI-CT Finish *Environmental Coatings Technology

[CLICK HERE TO VIEW PRODUCT INDEX](#)

1 SELECT A STYLE

DIMENSIONS		STYLE NUMBER		LIST PRICE	STYLE NUMBER		LIST PRICE	STYLE NUMBER		LIST PRICE
W" x D" x H"	WGT	"W" Veneer Veneer Top Veneer Chassis	"G" HPL High Pressure Laminate Top Veneer Chassis		"M" TFL Thermally Fused Laminate Top Thermally Fused Laminate Chassis					
3 Piece Top										
240 x 60	590	TBT24060AR500W	TBT24060AR500G	8302	TBT24060AR500M	8302			2657	
240 x 54	535	TBT24054AR500W	TBT24054AR500G	8192	TBT24054AR500M	8192			2615	
2 Piece Top										
216 x 60	535	TBT21660AR500W	TBT21660AR500G	7056	TBT21660AR500M	7056			2258	
216 x 54	485	TBT21654AR500W	TBT21654AR500G	6968	TBT21654AR500M	6968			2226	
192 x 54	430	TBT19254AR500W	TBT19254AR500G	5529	TBT19254AR500M	5529			1701	
168 x 54	310	TBT16854AR500W	TBT16854AR500G	5380	TBT16854AR500M	5380			1654	
144 x 48	230	TBT14448AR500W	TBT14448AR500G	4907	TBT14448AR500M	4907			1507	
120 x 48	190	TBT12048AR500W	TBT12048AR500G	4818	TBT12048AR500M	4818			1481	
1 Piece Top										
96 x 48	150	TBT9648AR500W	TBT9648AR500G	2756	TBT9648AR500M	2756			893	
84 x 42	110	TBT8442AR500W	TBT8442AR500G	2663	TBT8442AR500M	2663			798	
72 x 36	100	TBT7236AR500W	TBT7236AR500G	2273	TBT7236AR500M	2273			709	

2 SELECT A FINISH **3 SELECT AN EDGE** **5 OPTIONS**

"W" Veneer	"G" HPL	"M" TFL	Finish
WAC	GAC	-	Amber Cherry
WRC	-	-	Caramel Cherry
WIC	GIC	-	Crimson Cherry
WEC	-	-	Ebony Cherry
WHC	GHC	MHC	Honey Cherry
WOC	GOC	MOC	KoKo Cherry
WSC	-	-	Scotch Cherry
WAM	GAM	-	Alabaster Maple
WCM	GCM	-	Clear Maple
WWM	GWM	-	Wheat Maple
WBO	-	-	Blush Oak
WMO	-	-	Mocha Oak
WTO	-	-	Toast Oak
WWO	-	-	Wheat Oak
WEW	GEW	-	Executive Walnut
WRW	GRW	-	Gray Luster Walnut
WGW	-	MGW	Gunstock Walnut
WJW	-	-	Judicial Walnut
WNW	GNW	-	Natural Walnut
WTW	GTW	MTW	Studio Teak Walnut
WWP	GWL	MWL	Designer White

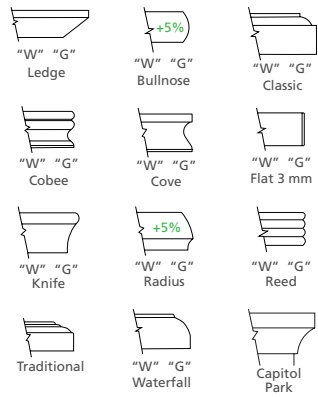

4 SELECT HARDWARE

Hardware Option Not Available

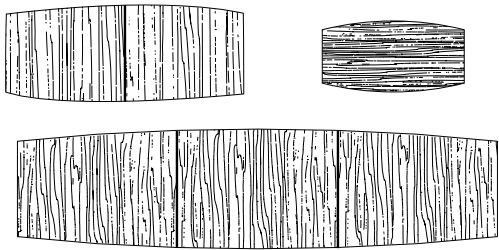

BOAT

STANDARD FEATURES

- 1.3125" thick
- BACGUARD SILVER anti-microbial protection
- ENVI-CT Finish *Environmental Coatings Technology

[CLICK HERE TO VIEW PRODUCT INDEX](#)

1 SELECT A STYLE

DIMENSIONS		STYLE NUMBER		LIST PRICE	STYLE NUMBER		LIST PRICE	STYLE NUMBER		LIST PRICE
W" x D" x H"	WGT	"W" Veneer Veneer Top Veneer Chassis	"G" HPL High Pressure Laminate Top Veneer Chassis		"M" TFL Thermally Fused Laminate Top Thermally Fused Laminate Chassis					
3 Piece Top										
240 x 60/48	590	TBT24060BT500W	TBT24060BT500G	8302	TBT24060BT500M		8302		TBT24060BT500M	2657
240 x 54/42	535	TBT24054BT500W	TBT24054BT500G	8192	TBT24054BT500M		8192		TBT24054BT500M	2615
2 Piece Top										
216 x 60/48	535	TBT21660BT500W	TBT21660BT500G	7056	TBT21660BT500M		7056		TBT21660BT500M	2258
216 x 54/42	485	TBT21654BT500W	TBT21654BT500G	6968	TBT21654BT500M		6968		TBT21654BT500M	2226
192 x 54 /42	430	TBT19254BT500W	TBT19254BT500G	5529	TBT19254BT500M		5529		TBT19254BT500M	1701
168 x 54 /42	310	TBT16854BT500W	TBT16854BT500G	5380	TBT16854BT500M		5380		TBT16854BT500M	1657
144 x 48 /39	230	TBT14448BT500W	TBT14448BT500G	4907	TBT14448BT500M		4907		TBT14448BT500M	1507
120 x 48 /39	190	TBT12048BT500W	TBT12048BT500G	4818	TBT12048BT500M		4818		TBT12048BT500M	1481
1 Piece Top										
96 x 48 /36	150	TBT9648BT500W	TBT9648BT500G	2756	TBT9648BT500M		2756		TBT9648BT500M	893
84 x 42 /32	120	TBT8442BT500W	TBT8442BT500G	2663	TBT8442BT500M		2663		TBT8442BT500M	798
72 x 36 /30	110	TBT7236BT500W	TBT7236BT500G	2273	TBT7236BT500M		2273		TBT7236BT500M	709

2 SELECT A FINISH

"W" Veneer	"G" HPL	"M" TFL	Finish
WAC	GAC	-	Amber Cherry
WRC	-	-	Caramel Cherry
WIC	GIC	-	Crimson Cherry
WEC	-	-	Ebony Cherry
WHC	GHC	MHC	Honey Cherry
WOC	GOC	MOC	KoKo Cherry
WSC	-	-	Scotch Cherry
WAM	GAM	-	Alabaster Maple
WCM	GCM	-	Clear Maple
WWM	GWM	-	Wheat Maple
WBO	-	-	Blush Oak
WMO	-	-	Mocha Oak
WTO	-	-	Toast Oak
WWO	-	-	Wheat Oak
WEW	GEW	-	Executive Walnut
WRW	GRW	-	Gray Luster Walnut
WGW	-	MGW	Gunstock Walnut
WJW	-	-	Judicial Walnut
WNW	GNW	-	Natural Walnut
WTW	GTW	MTW	Studio Teak Walnut
WWP	GWL	MWL	Designer White

3 SELECT AN EDGE

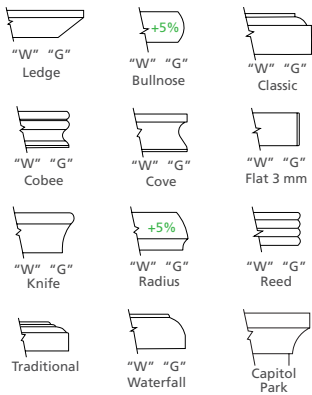

4 SELECT HARDWARE

Hardware Option Not Available

5 OPTIONS

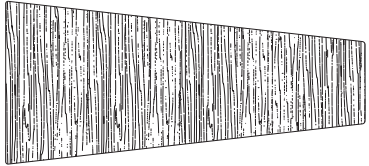
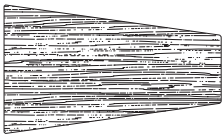

WEDGE

STANDARD FEATURES

- 1.3125" thick
- Tops and bases are pre-mounted to ensure proper installation location

[CLICK HERE TO VIEW PRODUCT INDEX](#)

1 SELECT A STYLE

DIMENSIONS		STYLE NUMBER		LIST PRICE	STYLE NUMBER		LIST PRICE	STYLE NUMBER		LIST PRICE
W" x D" x H"	WGT	"W" Veneer Veneer Top Veneer Chassis	"G" HPL High Pressure Laminate Top Veneer Chassis		"M" TFL Thermally Fused Laminate Top Thermally Fused Laminate Chassis					
2 Piece										
144 x 60/30	250	TBT14460WE400W	TBT14460WE400G	5380	TBT14460WE400M		5380		TBT14460WE400M	2016
132 x 60/30	235	TBT13260WE400W	TBT13260WE400G	5208	TBT13260WE400M		5208		TBT13260WE400M	1852
120 x 54/30	215	TBT12054WE400W	TBT12054WE400G	4946	TBT12054WE400M		4946		TBT12054WE400M	1602
1 Piece										
108 x 54/30	195	TBT10854WE400W	TBT10854WE400G	3234	TBT10854WE400M		3234		TBT10854WE400M	1481
96 x 51/30	170	TBT9651WE400W	TBT9651WE400G	2809	TBT9651WE400M		2809		TBT9651WE400M	943
84 x 48/30	135	TBT8448WE400W	TBT8448WE400G	2715	TBT8448WE400M		2715		TBT8448WE400M	848
72 x 42/28	105	TBT7242WE400W	TBT7242WE400G	2323	TBT7242WE400M		2323		TBT7242WE400M	759

2 SELECT A FINISH

"W" Veneer	"G" HPL	"M" TFL	Finish
WAC	GAC	-	Amber Cherry
WRC	-	-	Caramel Cherry
WIC	GIC	-	Crimson Cherry
WEC	-	-	Ebony Cherry
WHC	GHC	MHC	Honey Cherry
WOC	GOC	MOC	KoKo Cherry
WSC	-	-	Scotch Cherry
WAM	GAM	-	Alabaster Maple
WCM	GCM	-	Clear Maple
WWM	GWM	-	Wheat Maple
WBO	-	-	Blush Oak
WMO	-	-	Mocha Oak
WTO	-	-	Toast Oak
WWO	-	-	Wheat Oak
WEW	GEW	-	Executive Walnut
WRW	GRW	-	Gray Luster Walnut
WGW	-	MGW	Gunstock Walnut
WJW	-	-	Judicial Walnut
WNW	GNW	-	Natural Walnut
WTW	GTW	MTW	Studio Teak Walnut
WWP	GWL	MWL	Designer White

3 SELECT AN EDGE

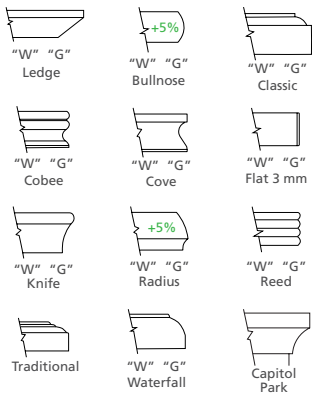

4 SELECT HARDWARE

Hardware Option Not Available

5 OPTIONS

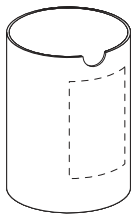

WOOD DRUM

STANDARD FEATURES

- Wire access door and open top and bottom allowing easy wire access

NOTES

- Drum bases can be used as center supports
- See base matrix to determine bases for specified top

[CLICK HERE TO VIEW PRODUCT INDEX](#)

1 SELECT A STYLE

DIMENSIONS	STYLE NUMBER	LIST PRICE	STYLE NUMBER	LIST PRICE	STYLE NUMBER	LIST PRICE
W" x D" x H"	"W" Veneer Top Veneer Chassis		"G" HPL High Pressure Laminate Top Veneer Chassis		"M" TFL Thermally Fused Laminate Top Thermally Fused Laminate Chassis	
For Tops Over 48" W						
24 DIA x 28.75	TBB2424WD969W	1400	"G" Option N/A		"M" Option N/A	
For tops 42" - 48" W						
20 DIA x 28.75	TBB2020WD969W	1330	"G" Option N/A		"M" Option N/A	
For tops less than 42" W						
16 DIA x 28.75	TBB1616WD969W	1260	"G" Option N/A		"M" Option N/A	

2 SELECT A FINISH **3 SELECT AN EDGE** **5 OPTIONS**

"W" Veneer	"G" HPL	"M" TFL	
WAC	-	-	Amber Cherry
WRC	-	-	Caramel Cherry
WIC	-	-	Crimson Cherry
WEC	-	-	Ebony Cherry
WHC	-	-	Honey Cherry
WOC	-	-	KoKo Cherry
WSC	-	-	Scotch Cherry
WAM	-	-	Alabaster Maple
WCM	-	-	Clear Maple
WWM	-	-	Wheat Maple
WEW	-	-	Executive Walnut
WRW	-	-	Gray Luster Walnut
WGW	-	-	Gunstock Walnut
WJW	-	-	Judicial Walnut
WNW	-	-	Natural Walnut
WTW	-	-	Studio Teak Walnut
WWP	-	-	Designer White

Edge Profile
Option Not Available

4 SELECT HARDWARE

Hardware
Option Not Available

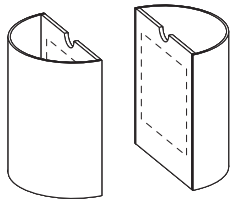

Drum bases can be used as center supports

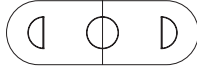

HALF WOOD DRUM

STANDARD FEATURES

- Wire access door and open top and bottom allowing easy wire access

NOTES

- Box bases can be used as center supports
- See base matrix to determine bases for specified top

[CLICK HERE TO VIEW PRODUCT INDEX](#)

1 SELECT A STYLE

DIMENSIONS	STYLE NUMBER	LIST PRICE	STYLE NUMBER	LIST PRICE	STYLE NUMBER	LIST PRICE
W" x D" x H"	"W" Veneer Top Veneer Chassis		"G" HPL High Pressure Laminate Top Veneer Chassis		"M" TFL Thermally Fused Laminate Top Thermally Fused Laminate Chassis	
For Tops Over 48" W						
24 x 12 x 28.75	TBB2412HD968W	1340	"G" Option N/A		"M" Option N/A	
For tops 42" - 48" W						
20 x 10 x 28.75	TBB2010HD968W	1270	"G" Option N/A		"M" Option N/A	
For tops less than 42" W						
16 x 8 x 28.75	TBB1608HD968W	1200	"G" Option N/A		"M" Option N/A	

2 SELECT A FINISH

"W" Veneer	"G" HPL	"M" TFL	Finish
WAC	-	-	Amber Cherry
WRC	-	-	Caramel Cherry
WIC	-	-	Crimson Cherry
WEC	-	-	Ebony Cherry
WHC	-	-	Honey Cherry
WOC	-	-	KoKo Cherry
WSC	-	-	Scotch Cherry
WAM	-	-	Alabaster Maple
WCM	-	-	Clear Maple
WWM	-	-	Wheat Maple
WEW	-	-	Executive Walnut
WRW	-	-	Gray Luster Walnut
WGW	-	-	Gunstock Walnut
WJW	-	-	Judicial Walnut
WNW	-	-	Natural Walnut
WTW	-	-	Studio Teak Walnut
WWP	-	-	Designer White

3 SELECT AN EDGE

Edge Profile
Option Not Available

4 SELECT HARDWARE

Hardware
Option Not Available

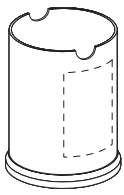

TRANSITIONAL WOOD CYLINDER BASE

STANDARD FEATURES

- Wire access door and open top and bottom allowing easy wire access

NOTES

- Drum bases can be used as center supports
- See base matrix to determine bases for specified top

[CLICK HERE TO VIEW PRODUCT INDEX](#)

1 SELECT A STYLE

DIMENSIONS		STYLE NUMBER	LIST PRICE	STYLE NUMBER	LIST PRICE	STYLE NUMBER	LIST PRICE
W" x D" x H"	WGT	"W" Veneer Veneer Top Veneer Chassis		"G" HPL High Pressure Laminate Top Veneer Chassis		"M" TFL Thermally Fused Laminate Top Thermally Fused Laminate Chassis	
For Tops Over 48" W							
24 DIA x 28.75	70	TBB2424TC969W	1590	"G" Option N/A		"M" Option N/A	
For tops 42" - 48" W							
20 DIA x 28.75	65	TBB2020TC969W	1495	"G" Option N/A		"M" Option N/A	
For tops less than 42" W							
16 DIA x 28.75	60	TBB1616TC969W	1400	"G" Option N/A		"M" Option N/A	

2 SELECT A FINISH **3 SELECT AN EDGE** **5 OPTIONS**

"W" Veneer	"G" HPL	"M" TFL	
WAC	-	-	Amber Cherry
WRC	-	-	Caramel Cherry
WIC	-	-	Crimson Cherry
WEC	-	-	Ebony Cherry
WHC	-	-	Honey Cherry
WOC	-	-	KoKo Cherry
WSC	-	-	Scotch Cherry
WAM	-	-	Alabaster Maple
WCM	-	-	Clear Maple
WWM	-	-	Wheat Maple
WEW	-	-	Executive Walnut
WRW	-	-	Gray Luster Walnut
WGW	-	-	Gunstock Walnut
WJW	-	-	Judicial Walnut
WNW	-	-	Natural Walnut
WTW	-	-	Studio Teak Walnut
WWP	-	-	Designer White

Edge Profile
Option Not Available

4 SELECT HARDWARE

Hardware
Option Not Available

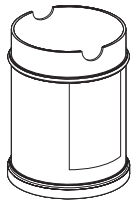

TRADITIONAL DRUM

STANDARD FEATURES

- 2.625" base w/ classic profile
- Beltline moldings
- Plywood drum
- Wire access door and open top and bottom allowing easy wire access

NOTES

- Drum bases can be used as center supports
- See base matrix to determine bases for specified top

[CLICK HERE TO VIEW PRODUCT INDEX](#)

1 SELECT A STYLE

DIMENSIONS	STYLE NUMBER	LIST PRICE	STYLE NUMBER	LIST PRICE	STYLE NUMBER	LIST PRICE
W" x D" x H"	"W" Veneer Top Veneer Chassis		"G" HPL High Pressure Laminate Top Veneer Chassis		"M" TFL Thermally Fused Laminate Top Thermally Fused Laminate Chassis	
For Tops Over 48" W						
24 DIA x 28.75	TBB2424TD969W	1590	"G" Option N/A		"M" Option N/A	
For tops 42" - 48" W						
20 DIA x 28.75	TBB2020TD969W	1495	"G" Option N/A		"M" Option N/A	
For tops 42" or less						
16 DIA x 28.75	TBB1616TD969W	1400	"G" Option N/A		"M" Option N/A	

2 SELECT A FINISH **3 SELECT AN EDGE** **5 OPTIONS**

"W" Veneer	"G" HPL	"M" TFL	
WAC	-	-	Amber Cherry
WRC	-	-	Caramel Cherry
WIC	-	-	Crimson Cherry
WEC	-	-	Ebony Cherry
WHC	-	-	Honey Cherry
WOC	-	-	KoKo Cherry
WSC	-	-	Scotch Cherry
WAM	-	-	Alabaster Maple
WCM	-	-	Clear Maple
WWM	-	-	Wheat Maple
WEW	-	-	Executive Walnut
WRW	-	-	Gray Luster Walnut
WGW	-	-	Gunstock Walnut
WJW	-	-	Judicial Walnut
WNW	-	-	Natural Walnut
WTW	-	-	Studio Teak Walnut
WWP	-	-	Designer White

Edge Profile
Option Not Available

4 SELECT HARDWARE

Hardware
Option Not Available

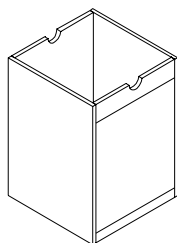

CONTEMPORARY CUBE BASE

STANDARD FEATURES

- 2 x 4 grommet cutout
- Open top and bottom

NOTES

- Access door standard
- See base matrix to determine bases for specified top

[CLICK HERE TO VIEW PRODUCT INDEX](#)

1 SELECT A STYLE

DIMENSIONS		STYLE NUMBER	LIST PRICE	STYLE NUMBER	LIST PRICE	STYLE NUMBER	LIST PRICE
W" x D" x H"	WGT	"W" Veneer Top Veneer Chassis		"G" HPL High Pressure Laminate Top Veneer Chassis		"M" TFL Thermally Fused Laminate Top Thermally Fused Laminate Chassis	
For Tops Over 48" W							
24 x 24 x 28.75	85	TBB2424CC962W	1030	"G" Option N/A		TBB2424CC962M	800
For tops 42" - 48" W							
20 x 20 x 28.75	70	TBB2020CC962W	980	"G" Option N/A		TBB2020CC962M	765
For tops less than 42" W							
16 x 16 x 28.75	60	TBB1616CC962W	930	"G" Option N/A		TBB1616CC962M	730

2 SELECT A FINISH **3 SELECT AN EDGE** **5 OPTIONS**

"W" Veneer	"G" HPL	"M" TFL	
WAC	-	-	Amber Cherry
WRC	-	-	Caramel Cherry
WIC	-	-	Crimson Cherry
WEC	-	-	Ebony Cherry
WHC	-	MHC	Honey Cherry
WOC	-	MOC	KoKo Cherry
WSC	-	-	Scotch Cherry
WAM	-	-	Alabaster Maple
WCM	-	-	Clear Maple
WWM	-	-	Wheat Maple
WBO	-	-	Blush Oak
WMO	-	-	Mocha Oak
WTO	-	-	Toast Oak
WWO	-	-	Wheat Oak
WEW	-	-	Executive Walnut
WRW	-	-	Gray Luster Walnut
GW	-	MGW	Gunstock Walnut
WJW	-	-	Judicial Walnut
WNW	-	-	Natural Walnut
WTW	-	MTW	Studio Teak Walnut
WWP	-	MWL	Designer White

Edge Profile
Option Not Available

4 SELECT HARDWARE

Hardware
Option Not Available

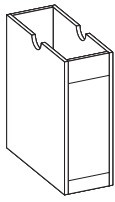

CONTEMPORARY HALF CUBE

STANDARD FEATURES

- 2 x 4 grommet cutout
- Open top and bottom

NOTES

- Access door standard
- See base matrix to determine bases for specified top

[CLICK HERE TO VIEW PRODUCT INDEX](#)

1 SELECT A STYLE

DIMENSIONS	STYLE NUMBER	LIST PRICE	STYLE NUMBER	LIST PRICE	STYLE NUMBER	LIST PRICE
W" x D" x H"	"W" Veneer Top Veneer Chassis		"G" HPL High Pressure Laminate Top Veneer Chassis		"M" TFL Thermally Fused Laminate Top Thermally Fused Laminate Chassis	
For Tops Over 48" W						
24 x 10 x 28.75	TBB2410CH977W	915	"G" Option N/A		TBB2410CH977M	710
For tops 42" - 48" W						
20 x 10 x 28.75	TBB2010CH977W	870	"G" Option N/A		TBB2010CH977M	680
For tops less than 42" W						
16 x 10 x 28.75	TBB1610CH977W	825	"G" Option N/A		TBB1610CH977M	650

2 SELECT A FINISH **3 SELECT AN EDGE** **5 OPTIONS**

"W" Veneer	"G" HPL	"M" TFL	Finish
WAC	-	-	Amber Cherry
WRC	-	-	Caramel Cherry
WIC	-	-	Crimson Cherry
WEC	-	-	Ebony Cherry
WHC	-	MHC	Honey Cherry
WOC	-	MOC	KoKo Cherry
WSC	-	-	Scotch Cherry
WAM	-	-	Alabaster Maple
WCM	-	-	Clear Maple
WWM	-	-	Wheat Maple
WBO	-	-	Blush Oak
WMO	-	-	Mocha Oak
WTO	-	-	Toast Oak
WWO	-	-	Wheat Oak
WEW	-	-	Executive Walnut
WRW	-	-	Gray Luster Walnut
GW	MGW	-	Gunstock Walnut
WJW	-	-	Judicial Walnut
WNW	-	-	Natural Walnut
WTW	-	MTW	Studio Teak Walnut
WWP	-	MWL	Designer White

Edge Profile
Option Not Available

4 SELECT HARDWARE

Hardware
Option Not Available

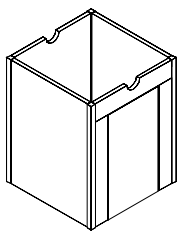

CONTEMPORARY CUBE W/ METAL DETAIL

STANDARD FEATURES

- 2 x 4 grommet cutout
- Adjustable glides
- Anodized aluminum metal feet

NOTES

- Access door
- See base matrix to determine bases for specified top

[CLICK HERE TO VIEW PRODUCT INDEX](#)

1 SELECT A STYLE

DIMENSIONS		STYLE NUMBER	LIST PRICE	STYLE NUMBER	LIST PRICE	STYLE NUMBER	LIST PRICE
W" x D" x H"	WGT	"W" Veneer Veneer Top Veneer Chassis		"G" HPL High Pressure Laminate Top Veneer Chassis		"M" TFL Thermally Fused Laminate Top Thermally Fused Laminate Chassis	
For Tops Over 48" W							
24 x 24 x 28.75	110	TBB2424CS962W	1575	"G" Option N/A		TBB2424CS962M	1230
For Tops 42" - 48" W							
20 x 20 x 28.75	85	TBB2020CS962W	1470	"G" Option N/A		TBB2020CS962M	1145
For tops less than 42" W							
16 x 16 x 28.75	70	TBB1616CS962W	1365	"G" Option N/A		TBB1616CS962M	1065

2 SELECT A FINISH **3 SELECT AN EDGE** **5 OPTIONS**

"W" Veneer	"G" HPL	"M" TFL	
WAC	-	-	Amber Cherry
WRC	-	-	Caramel Cherry
WIC	-	-	Crimson Cherry
WEC	-	-	Ebony Cherry
WHC	-	MHC	Honey Cherry
WOC	-	MOC	KoKo Cherry
WSC	-	-	Scotch Cherry
WAM	-	-	Alabaster Maple
WCM	-	-	Clear Maple
WWM	-	-	Wheat Maple
WBO	-	-	Blush Oak
WMO	-	-	Mocha Oak
WTO	-	-	Toast Oak
WWO	-	-	Wheat Oak
WEW	-	-	Executive Walnut
WRW	-	-	Gray Luster Walnut
GW	-	MGW	Gunstock Walnut
WJW	-	-	Judicial Walnut
WNW	-	-	Natural Walnut
WTW	-	MTW	Studio Teak Walnut
WWP	-	MWL	Designer White

Edge Profile
Option Not Available

4 SELECT HARDWARE

Hardware
Option Not Available

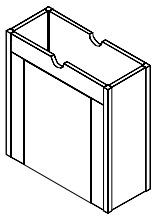

CONTEMPORARY HALF CUBE WITH METAL DETAIL

STANDARD FEATURES

- 2 x 4 grommet cutout
- Open top and bottom
- Metal details on each corner anodized aluminum

NOTES

- Access door
- See base matrix to determine bases for specified top

[CLICK HERE TO VIEW PRODUCT INDEX](#)

1 SELECT A STYLE

DIMENSIONS		STYLE NUMBER	LIST PRICE	STYLE NUMBER	LIST PRICE	STYLE NUMBER	LIST PRICE
W" x D" x H"	WGT	"W" Veneer Top Veneer Chassis		"G" HPL Top Veneer Chassis		"M" TFL Top Thermally Fused Laminate Chassis	
For Tops Over 48" W							
24 x 10 x 28.75	85	TBB2410HS975W	1455	"G" Option N/A		TBB2410HS975M	1135
For tops 42" - 48" W							
20 x 10 x 28.75	65	TBB2010HS975W	1375	"G" Option N/A		TBB2010HS975M	1075
For tops less than 42" W							
16 x 10 x 28.75	45	TBB1610HS975W	1295	"G" Option N/A		TBB1610HS975M	1010

2 SELECT A FINISH **3 SELECT AN EDGE** **5 OPTIONS**

"W" Veneer	"G" HPL	"M" TFL	
WAC	-	-	Amber Cherry
WRC	-	-	Caramel Cherry
WIC	-	-	Crimson Cherry
WEC	-	-	Ebony Cherry
WHC	-	MHC	Honey Cherry
WOC	-	MOC	KoKo Cherry
WSC	-	-	Scotch Cherry
WAM	-	-	Alabaster Maple
WCM	-	-	Clear Maple
WWM	-	-	Wheat Maple
WBO	-	-	Blush Oak
WMO	-	-	Mocha Oak
WTO	-	-	Toast Oak
WWO	-	-	Wheat Oak
WEW	-	-	Executive Walnut
WRW	-	-	Gray Luster Walnut
GW	-	MGW	Gunstock Walnut
WJW	-	-	Judicial Walnut
WNW	-	-	Natural Walnut
WTW	-	MTW	Studio Teak Walnut
WWP	-	MWL	Designer White

Edge Profile
Option Not Available

4 SELECT HARDWARE

Hardware
Option Not Available

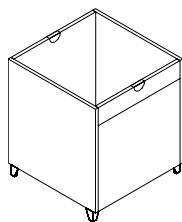

CUBE BASE WITH LEGS

STANDARD FEATURES

- 2 x 4 grommet cutout
- Adjustable glides
- Anodized aluminum metal feet

NOTES

- See base matrix to determine bases for specified top

[CLICK HERE TO VIEW PRODUCT INDEX](#)

1 SELECT A STYLE

DIMENSIONS	STYLE NUMBER	LIST PRICE	STYLE NUMBER	LIST PRICE	STYLE NUMBER	LIST PRICE
W" x D" x H"	"W" Veneer Top Veneer Chassis		"G" HPL High Pressure Laminate Top Veneer Chassis		"M" TFL Thermally Fused Laminate Top Thermally Fused Laminate Chassis	
For Tops Over 48" W						
24 x 24 x 28.75	TBB2424CS974W	1575	"G" Style N/A		TBB2424CS974M	921
For tops 42" - 48" W						
20 x 20 x 28.75	TBB2020CS974W	1470	"G" Option N/A		TBB2020CS974M	889
For tops less than 42" W						
16 x 16 x 28.75	TBB1616CS974W	1365	"G" Option N/A		TBB1616CS974M	861

2 SELECT A FINISH

"W" Veneer	"G" HPL	"M" TFL	
WAC	-	-	Amber Cherry
WRC	-	-	Caramel Cherry
WIC	-	-	Crimson Cherry
WEC	-	-	Ebony Cherry
WHC	-	MHC	Honey Cherry
WOC	-	MOC	KoKo Cherry
WSC	-	-	Scotch Cherry
WAM	-	-	Alabaster Maple
WCM	-	-	Clear Maple
WWM	-	-	Wheat Maple
WBO	-	-	Blush Oak
WMO	-	-	Mocha Oak
WTO	-	-	Toast Oak
WWO	-	-	Wheat Oak
WEW	-	-	Executive Walnut
WRW	-	-	Gray Luster Walnut
WGW	-	MGW	Gunstock Walnut
WJW	-	-	Judicial Walnut
WNW	-	-	Natural Walnut
WOW	-	MOW	Clear Walnut
WTW	-	MTW	Studio Teak Walnut
WWP	-	MWL	Designer White

3 SELECT AN EDGE

Edge Profile
Option Not Available

5 OPTIONS

4 SELECT HARDWARE

Hardware
Option Not Available

METAL FINISHES

MFW	-	-	White (Premium Finish)
MFB	-	-	Matte Black (Premium Finish)

MFS - - Silver

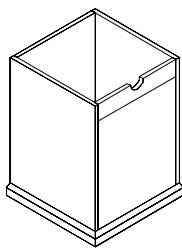

TRANSITIONAL CUBE

STANDARD FEATURES

- Open top and bottom
- Transitional - Hardwood base 2 1/2" H

NOTES

- Access door
- See base matrix to determine bases for specified top

[CLICK HERE TO VIEW PRODUCT INDEX](#)

1 SELECT A STYLE

DIMENSIONS	STYLE NUMBER	LIST PRICE	STYLE NUMBER	LIST PRICE	STYLE NUMBER	LIST PRICE
W" x D" x H"	"W" Veneer Top Veneer Chassis		"G" HPL High Pressure Laminate Top Veneer Chassis		"M" TFL Thermally Fused Laminate Top Thermally Fused Laminate Chassis	
For Tops Over 48" W						
24 x 24 x 28.75	TBB2424TR962W	1185	"G" Option N/A		"M" Option N/A	
For tops 42" - 48" W						
20 x 20 x 28.75	TBB2020TR962W	1100	"G" Option N/A		"M" Option N/A	
For tops less than 42" W						
16 x 16 x 28.75	TBB1616TR962W	1015	"G" Option N/A		"M" Option N/A	

2 SELECT A FINISH

"W" Veneer	"G" HPL	"M" TFL	
WAC	-	-	Amber Cherry
WRC	-	-	Caramel Cherry
WIC	-	-	Crimson Cherry
WEC	-	-	Ebony Cherry
WHC	-	-	Honey Cherry
WOC	-	-	KoKo Cherry
WSC	-	-	Scotch Cherry
WAM	-	-	Alabaster Maple
WCM	-	-	Clear Maple
WWM	-	-	Wheat Maple
WEW	-	-	Executive Walnut
WRW	-	-	Gray Luster Walnut
WGW	-	-	Gunstock Walnut
WJW	-	-	Judicial Walnut
WNW	-	-	Natural Walnut
WTW	-	-	Studio Teak Walnut
WWP	-	-	Designer White

3 SELECT AN EDGE

Edge Profile
Option Not Available

5 OPTIONS

4 SELECT HARDWARE

Hardware
Option Not Available

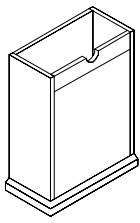

TRANSITIONAL HALF CUBE

STANDARD FEATURES

- 2 x 4 grommet cutout
- Transitional - Hardwood base 2 1/2" H
- Open top and bottom

NOTES

- Access door
- See base matrix to determine bases for specified top

[CLICK HERE TO VIEW PRODUCT INDEX](#)

1 SELECT A STYLE

DIMENSIONS	STYLE NUMBER	LIST PRICE	STYLE NUMBER	LIST PRICE	STYLE NUMBER	LIST PRICE
W" x D" x H"	"W" Veneer Top Veneer Chassis		"G" HPL High Pressure Laminate Top Veneer Chassis		"M" TFL Thermally Fused Laminate Top Thermally Fused Laminate Chassis	
For Tops Over 48" W						
24 x 10 x 28.75	TBB2410TR977W	1015	"G" Option N/A		"M" Option N/A	
For tops 42" - 48" W						
20 x 10 x 28.75	TBB2010TR977W	960	"G" Option N/A		"M" Option N/A	
For tops less than 42" W						
16 x 10 x 28.75	TBB1610TR977W	905	"G" Option N/A		"M" Option N/A	

2 SELECT A FINISH

"W" Veneer	"G" HPL	"M" TFL	
WAC	-	-	Amber Cherry
WRC	-	-	Caramel Cherry
WIC	-	-	Crimson Cherry
WEC	-	-	Ebony Cherry
WHC	-	-	Honey Cherry
WOC	-	-	KoKo Cherry
WSC	-	-	Scotch Cherry
WAM	-	-	Alabaster Maple
WCM	-	-	Clear Maple
WWM	-	-	Wheat Maple
WEW	-	-	Executive Walnut
WRW	-	-	Gray Luster Walnut
WGW	-	-	Gunstock Walnut
WJW	-	-	Judicial Walnut
WNW	-	-	Natural Walnut
WTW	-	-	Studio Teak Walnut
WWP	-	-	Designer White

3 SELECT AN EDGE

Edge Profile
Option Not Available

5 OPTIONS

4 SELECT HARDWARE

Hardware
Option Not Available

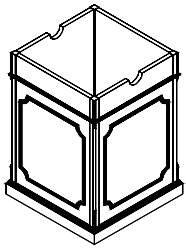

CONFERENCE BASES

TRADITIONAL CUBE BASES

FULL TRADITIONAL CABINET BASES

STANDARD FEATURES

- 2 x 4 grommet cutout
- Hardwood beltline molding
- Hardwood corner post and base
- Molding
- Open bottom
- 3 1/2 base

specified top

NOTES

- Access door
- See base matrix to determine bases for

[CLICK HERE TO VIEW PRODUCT INDEX](#)

1 SELECT A STYLE

DIMENSIONS	STYLE NUMBER	LIST PRICE	STYLE NUMBER	LIST PRICE	STYLE NUMBER	LIST PRICE
W" x D" x H"	"W" Veneer Top Veneer Chassis		"G" HPL High Pressure Laminate Top Veneer Chassis		"M" TFL Thermally Fused Laminate Top Thermally Fused Laminate Chassis	
For Tops Over 48" W						
24 x 24 x 28.75	TBB2424TC962W	1640	"G" Option N/A		"M" Option N/A	
For tops 42" - 48" W						
20 x 20 x 28.75	TBB2020TC962W	1515	"G" Option N/A		"M" Option N/A	
For tops less than 42" W						
16 x 16 x 28.75	TBB1616TC962W	1390	"G" Option N/A		"M" Option N/A	

2 SELECT A FINISH

"W" Veneer	"G" HPL	"M" TFL	
WAC	-	-	Amber Cherry
WRC	-	-	Caramel Cherry
WIC	-	-	Crimson Cherry
WEC	-	-	Ebony Cherry
WHC	-	-	Honey Cherry
WOC	-	-	KoKo Cherry
WSC	-	-	Scotch Cherry
WAM	-	-	Alabaster Maple
WEW	-	-	Executive Walnut
WRW	-	-	Gray Luster Walnut
WGW	-	-	Gunstock Walnut
WJW	-	-	Judicial Walnut
WNW	-	-	Natural Walnut
WTW	-	-	Studio Teak Walnut

3 SELECT AN EDGE

Edge Profile
Option Not Available

5 OPTIONS

MOLDING
- DSM2: Delete molding - Deduct \$50

4 SELECT HARDWARE

Hardware
Option Not Available

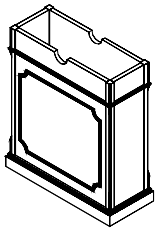

CONFERENCE BASES

TRADITIONAL CUBE BASES

HALF TRADITIONAL CABINET BASE

STANDARD FEATURES

- 2 x 4 grommet cutout
- Hardwood beltline molding
- Hardwood corner post and base
- Molding
- Open bottom

NOTES

- Access door
- See base matrix to determine bases for specified top

[CLICK HERE TO VIEW PRODUCT INDEX](#)

1 SELECT A STYLE

DIMENSIONS	STYLE NUMBER	LIST PRICE	STYLE NUMBER	LIST PRICE	STYLE NUMBER	LIST PRICE
W" x D" x H"	"W" Veneer Top Veneer Chassis		"G" HPL High Pressure Laminate Top Veneer Chassis		"M" TFL Thermally Fused Laminate Top Thermally Fused Laminate Chassis	
For Tops Over 48" W						
24 x 10 x 28.75	TBB2410TH977W	1325	"G" Option N/A		"M" Option N/A	
For tops 42" - 48" W						
20 x 10 x 28.75	TBB2010TH977W	1255	"G" Option N/A		"M" Option N/A	
For tops less than 42" W						
16 x 10 x 28.75	TBB1610TH977W	1195	"G" Option N/A		"M" Option N/A	

2 SELECT A FINISH

"W" Veneer	"G" HPL	"M" TFL	
WAC	-	-	Amber Cherry
WRC	-	-	Caramel Cherry
WIC	-	-	Crimson Cherry
WEC	-	-	Ebony Cherry
WHC	-	-	Honey Cherry
WOC	-	-	KoKo Cherry
WSC	-	-	Scotch Cherry
WAM	-	-	Alabaster Maple
WEW	-	-	Executive Walnut
WRW	-	-	Gray Luster Walnut
WGW	-	-	Gunstock Walnut
WJW	-	-	Judicial Walnut
WNW	-	-	Natural Walnut
WTW	-	-	Studio Teak Walnut

3 SELECT AN EDGE

Edge Profile
Option Not Available

5 OPTIONS

MOLDING
- DSM2: Delete molding - Deduct \$50

4 SELECT HARDWARE

Hardware
Option Not Available

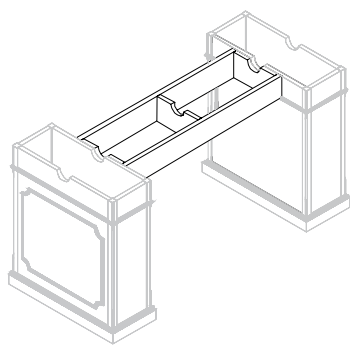

4 3/4" H WIRE TROUGH MODESTY

STANDARD FEATURES

- Open Bottom
- Wire grommets and channels

traditional bases

NOTES

- Actual dimension is 4 3/4"
- Interior base molding will be deleted on Traditional bases.
- Must order bases separately. Bases and Rack shipped separately. Requires assembly.
- Trough can be used on both contemporary and

[CLICK HERE TO VIEW PRODUCT INDEX](#)

1 SELECT A STYLE

DIMENSIONS		STYLE NUMBER	LIST PRICE	STYLE NUMBER	LIST PRICE	STYLE NUMBER	LIST PRICE
W" x D" x H"	WGT	"W" Veneer Top Veneer Chassis		"G" High Pressure Laminate Top Veneer Chassis		"M" Thermally Fused Laminate Top Thermally Fused Laminate Chassis	
Quantity 3							
240"	90	WT04-240W	2393	"G" Option N/A		WT04-240M	1675
216"	100	WT04-216W	2258	"G" Option N/A		WT04-216M	1581
Quantity 2							
192"	210	WT04-192W	2027	"G" Option N/A		WT04-192M	1485
168"	190	WT04-168W	1897	"G" Option N/A		WT04-168M	1390
144"	170	WT04-144W	1766	"G" Option N/A		WT04-144M	1295
Quantity 1							
120"	110	WT04-120W	1022	"G" Option N/A		WT04-120M	750
96"	100	WT04-96W	891	"G" Option N/A		WT04-96M	655
84"	95	WT04-84W	761	"G" Option N/A		WT04-84M	560

2 SELECT A FINISH **3 SELECT AN EDGE** **5 OPTIONS**

"W" Veneer	"G" HPL	"M" TFL	Finish
WAC	-	-	Amber Cherry
WRC	-	-	Caramel Cherry
WIC	-	-	Crimson Cherry
WEC	-	-	Ebony Cherry
WHC	-	MHC	Honey Cherry
WOC	-	MOC	KoKo Cherry
WSC	-	-	Scotch Cherry
WAM	-	-	Alabaster Maple
WCM	-	-	Clear Maple
WWM	-	-	Wheat Maple
WEW	-	-	Executive Walnut
WRW	-	-	Gray Luster Walnut
WGW	-	MGW	Gunstock Walnut
WJW	-	-	Judicial Walnut
WNW	-	-	Natural Walnut
WTW	-	MTW	Studio Teak Walnut
WWP	-	MWL	Designer White

Edge Profile
Option Not Available

4 SELECT HARDWARE

Hardware
Option Not Available

PANEL BASE W/ WIRE MANAGEMENT MODESTY

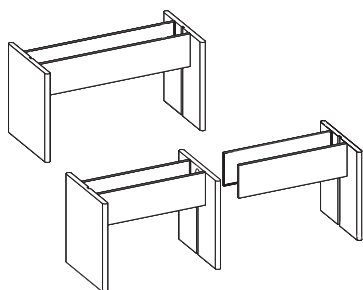

PANEL BASE

STANDARD FEATURES

- 1.3125" thick end panels
- 3mm wood bands
- Anti-glide tearout band
- Wire management channels
- Wire trough modesty

NOTES

- 2 panel base Factory assembled
- 3 panels - shipped 2 sections
- Base height: 28.75"H

[CLICK HERE TO VIEW PRODUCT INDEX](#)

1 SELECT A STYLE

DIMENSIONS		STYLE NUMBER	LIST PRICE	STYLE NUMBER	LIST PRICE	STYLE NUMBER	LIST PRICE
W" x D" x H"	WGT	"W" Veneer Top Veneer Chassis		"G" HPL High Pressure Laminate Top Veneer Chassis		"M" TFL Thermally Fused Laminate Top Thermally Fused Laminate Chassis	
3 Panel Base for Tables							
240"	205	TBB20424PB972W	5030	"G" Option N/A		"M" Option N/A	
216"	190	TBB18024PB972W	4630	"G" Option N/A		"M" Option N/A	
192"	175	TBB15624PB972W	4230	"G" Option N/A		"M" Option N/A	
168"	160	TBB13224PB972W	3830	"G" Option N/A		"M" Option N/A	
144"	150	TBB10824PB972W	3430	"G" Option N/A		"M" Option N/A	
2 Panel Base for Tables							
120"	100	TBB8424PB972W	2340	"G" Option N/A		"M" Option N/A	
96"	100	TBB6024PB972W	1915	"G" Option N/A		"M" Option N/A	
84"	100	TBB5424PB972W	1865	"G" Option N/A		"M" Option N/A	

2 SELECT A FINISH

"W" Veneer	"G" HPL	"M" TFL	Finish
WAC	-	-	Amber Cherry
WRC	-	-	Caramel Cherry
WIC	-	-	Crimson Cherry
WEC	-	-	Ebony Cherry
WHC	-	-	Honey Cherry
WOC	-	-	KoKo Cherry
WSC	-	-	Scotch Cherry
WAM	-	-	Alabaster Maple
WCM	-	-	Clear Maple
WWM	-	-	Wheat Maple
WBO	-	-	Blush Oak
WMO	-	-	Mocha Oak
WTO	-	-	Toast Oak
WWO	-	-	Wheat Oak
WEW	-	-	Executive Walnut
WRW	-	-	Gray Luster Walnut
GW	-	-	Gunstock Walnut
WJW	-	-	Judicial Walnut
WNW	-	-	Natural Walnut
WTW	-	-	Studio Teak Walnut
WWP	-	-	Designer White

3 SELECT AN EDGE

Edge Profile
Option Not Available

5 OPTIONS

4 SELECT HARDWARE

Hardware
Option Not Available

PANEL BASE W/ WIRE MANAGEMENT MODESTY

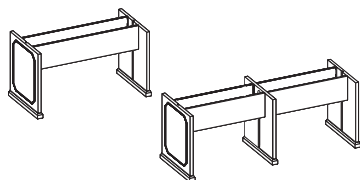

TRADITIONAL PANEL BASE

STANDARD FEATURES

- 1.3125" thick end panels
- 2.125" x 2" hardwood base
- 3mm wood bands
- Scalloped moldings
- Wire management channels
- Wire trough modesty

NOTES

- Base Height: 28.75"H

[CLICK HERE TO VIEW PRODUCT INDEX](#)

1 SELECT A STYLE

DIMENSIONS		STYLE NUMBER	LIST PRICE	STYLE NUMBER	LIST PRICE	STYLE NUMBER	LIST PRICE
W" x D" x H"	WGT	"W" Veneer Top Veneer Chassis		"G" High Pressure Laminate Top Veneer Chassis		"M" Thermally Fused Laminate Top Thermally Fused Laminate Chassis	
3 Panel Base for Tables							
240"	205	TBB20424TB972W	5533	"G" Option N/A		"M" Option N/A	
216"	190	TBB18024TB972W	5093	"G" Option N/A		"M" Option N/A	
192"	175	TBB15624TB972W	4653	"G" Option N/A		"M" Option N/A	
168"	160	TBB13224TB972W	4213	"G" Option N/A		"M" Option N/A	
144"	150	TBB10824TB972W	3773	"G" Option N/A		"M" Option N/A	
2 Panel Base for Tables							
120"	100	TBB8424TB972W	2574	"G" Option N/A		"M" Option N/A	
96"	100	TBB6024TB972W	2107	"G" Option N/A		"M" Option N/A	
84"	100	TBB5424TB972W	2052	"G" Option N/A		"M" Option N/A	

2 SELECT A FINISH **3 SELECT AN EDGE** **5 OPTIONS**

"W" Veneer	"G" HPL	"M" TFL	
WAC	-	-	Amber Cherry
WRC	-	-	Caramel Cherry
WIC	-	-	Crimson Cherry
WEC	-	-	Ebony Cherry
WHC	-	-	Honey Cherry
WOC	-	-	KoKo Cherry
WSC	-	-	Scotch Cherry
WAM	-	-	Alabaster Maple
WEW	-	-	Executive Walnut
WRW	-	-	Gray Luster Walnut
WGW	-	-	Gunstock Walnut
WJW	-	-	Judicial Walnut
WNW	-	-	Natural Walnut
WTW	-	-	Studio Teak Walnut

Edge Profile
Option Not Available

MOLDING
- DSM2: Delete molding - Deduct \$50

4 SELECT HARDWARE

Hardware
Option Not Available

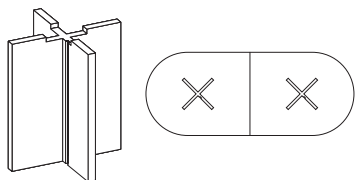

PANEL X BASE

STANDARD FEATURES

- 1.3125 thick end panels with 3mm wood bands

NOTES

- Panel x base can be used as center support with Panel T base on 2 pc tops.

[CLICK HERE TO VIEW PRODUCT INDEX](#)

1 SELECT A STYLE

DIMENSIONS		STYLE NUMBER	LIST PRICE	STYLE NUMBER	LIST PRICE	STYLE NUMBER	LIST PRICE
W" x D" x H"	WGT	"W" Veneer Top Veneer Chassis		"G" High Pressure Laminate Top Veneer Chassis		"M" Thermally Fused Laminate Top Thermally Fused Laminate Chassis	
For Tops 60" W							
30 x 30 x 28.75	65	TBB3030PX966W	1280	"G" Option N/A		TBB3030PX966M	895
For Tops 48" - 54" W							
24 x 24 x 28.75	55	TBB2424PX966W	1200	"G" Option N/A		TBB2424PX966M	840
For tops 36" - 42" W							
18 x 18 x 28.75	45	TBB1818PX966W	1120	"G" Option N/A		TBB1818PX966M	795

2 SELECT A FINISH **3 SELECT AN EDGE** **5 OPTIONS**

"W" Veneer	"G" HPL	"M" TFL	Finish
WAC	-	-	Amber Cherry
WRC	-	-	Caramel Cherry
WIC	-	-	Crimson Cherry
WEC	-	-	Ebony Cherry
WHC	-	MHC	Honey Cherry
WOC	-	MOC	KoKo Cherry
WSC	-	-	Scotch Cherry
WAM	-	-	Alabaster Maple
WCM	-	-	Clear Maple
WWM	-	-	Wheat Maple
WBO	-	-	Blush Oak
WMO	-	-	Mocha Oak
WTO	-	-	Toast Oak
WWO	-	-	Wheat Oak
WEW	-	-	Executive Walnut
WRW	-	-	Gray Luster Walnut
GW	-	MGW	Gunstock Walnut
WJW	-	-	Judicial Walnut
WNW	-	-	Natural Walnut
WTW	-	MTW	Studio Teak Walnut
WWP	-	MWL	Designer White

Edge Profile
Option Not Available

4 SELECT HARDWARE

Hardware
Option Not Available

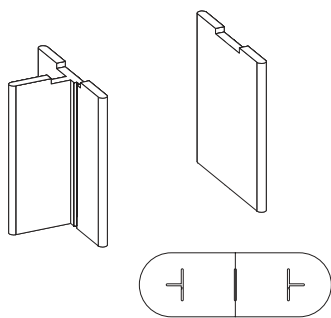

PANEL T BASE

STANDARD FEATURES

- 1.3125 thick end panels with 3mm wood bands

[CLICK HERE TO VIEW PRODUCT INDEX](#)

1 SELECT A STYLE

DIMENSIONS		STYLE NUMBER	LIST PRICE	STYLE NUMBER	LIST PRICE	STYLE NUMBER	LIST PRICE
W" x D" x H"	WGT	"W" Veneer Top Veneer Chassis		"G" HPL High Pressure Laminate Top Veneer Chassis		"M" TFL Thermally Fused Laminate Top Thermally Fused Laminate Chassis	
Single Panel Center Support For 2 PC Tops							
24 x 28.75	40	TBB2402SP957W	895	"G" Option N/A		TBB2402SP957M	800
For Tops 48" - 54" W							
24 x 12 x 28.75	80	TBB2412TB963W	870	"G" Option N/A		TBB2412TB963M	780
For tops 36" - 42" W							
18 x 12 x 28.75	70	TBB1812TB963W	815	"G" Option N/A		TBB1812TB963M	750

2 SELECT A FINISH **3 SELECT AN EDGE** **5 OPTIONS**

"W" Veneer	"G" HPL	"M" TFL	Finish
WAC	-	-	Amber Cherry
WRC	-	-	Caramel Cherry
WIC	-	-	Crimson Cherry
WEC	-	-	Ebony Cherry
WHC	-	MHC	Honey Cherry
WOC	-	MOC	KoKo Cherry
WSC	-	-	Scotch Cherry
WAM	-	-	Alabaster Maple
WCM	-	-	Clear Maple
WWM	-	-	Wheat Maple
WBO	-	-	Blush Oak
WMO	-	-	Mocha Oak
WTO	-	-	Toast Oak
WWO	-	-	Wheat Oak
WEW	-	-	Executive Walnut
WRW	-	-	Gray Luster Walnut
GW	MGW	-	Gunstock Walnut
WJW	-	-	Judicial Walnut
WNW	-	-	Natural Walnut
WTW	-	MTW	Studio Teak Walnut
WWP	-	MWL	Designer White

Edge Profile
Option Not Available

4 SELECT HARDWARE

Hardware
Option Not Available

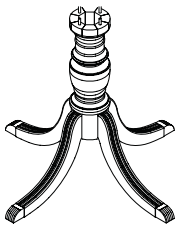

CONFERENCE BASES

TRADITIONAL BASES

TRADITIONAL DUNCAN PHYFE PEDESTAL BASE

STANDARD FEATURES

- 5 3/4" DIA column
- 13 1/2" Curve leg 12" High
- 24" DIA Sub top bolted to top of column (for attachment to top)
- Choose metal toe cap finish

[CLICK HERE TO VIEW PRODUCT INDEX](#)

1 SELECT A STYLE

DIMENSIONS		STYLE NUMBER	LIST PRICE	STYLE NUMBER	LIST PRICE	STYLE NUMBER	LIST PRICE
W" x D" x H"	WGT	"W" Veneer Top Veneer Chassis		"G" HPL High Pressure Laminate Top Veneer Chassis		"M" TFL Thermally Fused Laminate Top Thermally Fused Laminate Chassis	
31 x 31 x 29.5	35	TBB3131PB955W	1585	"G" Option N/A		"M" Option N/A	

2 SELECT A FINISH

"W"	"G"	"M"	
Veneer	HPL	TFL	
WAC	-	-	Amber Cherry
WRC	-	-	Caramel Cherry
WIC	-	-	Crimson Cherry
WEC	-	-	Ebony Cherry
WHC	-	-	Honey Cherry
WOC	-	-	KoKo Cherry
WSC	-	-	Scotch Cherry
WAM	-	-	Alabaster Maple
WEW	-	-	Executive Walnut
WRW	-	-	Gray Luster Walnut
WGW	-	-	Gunstock Walnut
WJW	-	-	Judicial Walnut
WNW	-	-	Natural Walnut
WTW	-	-	Studio Teak Walnut
METAL FINISHES			
ABT	-	-	Antique Brass
BPT	-	-	Pewter

3 SELECT AN EDGE

Edge Profile
Option Not Available

5 OPTIONS

4 SELECT HARDWARE

Hardware
Option Not Available

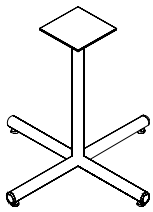

COLUMN "X" SERIES

STANDARD FEATURES

- Standard Silver base (optional Black)
- Available with casters

[CLICK HERE TO VIEW PRODUCT INDEX](#)

1 SELECT A STYLE

DIMENSIONS		STYLE NUMBER	LIST PRICE	STYLE NUMBER	LIST PRICE	STYLE NUMBER	LIST PRICE
W" x D" x H"	WGT	"C" Component					
36 x 36 x 27.75	35	TBB3636MB971	495	"G" Option N/A		"M" Option N/A	
32 x 32 x 27.75	30	TBB3232MB971	475	"G" Option N/A		"M" Option N/A	

2 SELECT A FINISH **3 SELECT AN EDGE** **5 OPTIONS**

"C" Component
 METAL FINISHES
 MFS - - Silver

Edge Profile
 Option Not Available

CASTERS
 - CAS20L: Casters - \$190

4 SELECT HARDWARE

Hardware
 Option Not Available

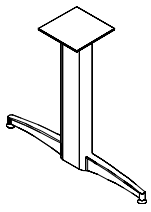

METAL OVAL "T" BASE

STANDARD FEATURES

- Standard Silver base (optional Black)
- Available with casters

[CLICK HERE TO VIEW PRODUCT INDEX](#)

1 SELECT A STYLE

DIMENSIONS		STYLE NUMBER	LIST PRICE	STYLE NUMBER	LIST PRICE	STYLE NUMBER	LIST PRICE
W" x D" x H"	WGT	"C" Component					
36 x 2 x 27.75	18	TBB3602MB956	675	"G" Option N/A		"M" Option N/A	
32 x 2 x 27.75	15	TBB3202MB956	645	"G" Option N/A		"M" Option N/A	

2 SELECT A FINISH **3 SELECT AN EDGE** **5 OPTIONS**

"C" Comp
 METAL FINISHES
 MFS - - Silver

Edge Profile
 Option Not Available

CASTERS
 - CAS20L: Casters - \$95 per base

4 SELECT HARDWARE

Hardware
 Option Not Available

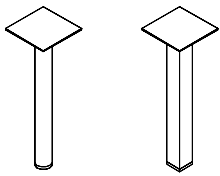

3" METAL LEG - KD

STANDARD FEATURES

- Available with casters
- Standard Silver base (optional Black)

[CLICK HERE TO VIEW PRODUCT INDEX](#)

1 SELECT A STYLE

DIMENSIONS		STYLE NUMBER	LIST PRICE	STYLE NUMBER	LIST PRICE	STYLE NUMBER	LIST PRICE
W" x D" x H"	WGT	"C" Component					
Round Leg							
3 dia. x 27.75	15	TBB0303MB982	215	"G" Option N/A		"M" Option N/A	
Square Leg							
3 x 3 x 27.75	15	TBB0303MB976	200	"G" Option N/A		"M" Option N/A	

2 SELECT A FINISH **3 SELECT AN EDGE** **5 OPTIONS**

"C" Comp
METAL FINISHES
MFS - - Silver

Edge Profile
Option Not Available

CASTERS
- CAS20L: Casters - \$95 per base

4 SELECT HARDWARE

Hardware
Option Not Available

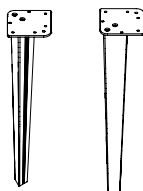

TAPERED/TRIANGLE METAL LEG

STANDARD FEATURES

- Standard Silver base (optional White, Black)

NOTES

/ Brush Standard on all Legs

[CLICK HERE TO VIEW PRODUCT INDEX](#)

1 SELECT A STYLE

DIMENSIONS		STYLE NUMBER	LIST PRICE	STYLE NUMBER	LIST PRICE	STYLE NUMBER	LIST PRICE
W" x D" x H"	WGT	"C" Component					
3.75 x 1.5 x 28.25	15	TBB0301MB985	435				

2 SELECT A FINISH **3 SELECT AN EDGE** **5 OPTIONS**

"C" Comp

METAL FINISHES

MFB	-	-	Black (Premium Finish)
MFS	-	-	Silver
MFW	-	-	White (Premium Finish)

Edge Profile
Option Not Available

PREMIUM FINISH OPTION
- MFB: Black metal finish - \$95 per base
- MFW: White metal finish - \$95 per base

4 SELECT HARDWARE

Hardware
Option Not Available

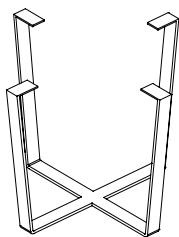

METAL ANGLED SLEIGH BASE

STANDARD FEATURES

- Standard Silver base (optional White, Black)

[CLICK HERE TO VIEW PRODUCT INDEX](#)

1 SELECT A STYLE

DIMENSIONS		STYLE NUMBER	LIST PRICE	STYLE NUMBER	LIST PRICE	STYLE NUMBER	LIST PRICE
W" x D" x H"	WGT	"C" Component					
36 x 36 x 28.5	65	TBB3030MB984	1183				

2 SELECT A FINISH

"C" Comp

METAL FINISHES

MFB	-	-	Black (Premium Finish)
MFS	-	-	Silver
MFW	-	-	White (Premium Finish)

3 SELECT AN EDGE

Edge Profile
Option Not Available

5 OPTIONS

PREMIUM FINISH OPTION
- MFB: Black metal finish - \$95 per base
- MFW: White metal finish - \$95 per base

4 SELECT HARDWARE

Hardware
Option Not Available

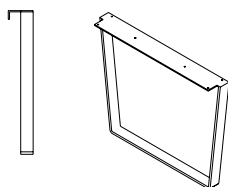

SINGLE METAL LEG

STANDARD FEATURES

- Legs have been laser cut and bent to create unique not so square shape
- Standard Silver base (optional White, Black)
- Top connection of leg is reinforced with turn downs that will keep tops from warping

[CLICK HERE TO VIEW PRODUCT INDEX](#)

1 SELECT A STYLE

DIMENSIONS		STYLE NUMBER	LIST PRICE	STYLE NUMBER	LIST PRICE	STYLE NUMBER	LIST PRICE
W" x D" x H"	WGT	"C" Comp Component					
36 x 3 x 27-3/4	50	NSS3603MB988	580	"G" Style N/A		"M" Option N/A	
30 x 3 x 27-3/4	40	NSS3003MB988	560	"G" Style N/A		"M" Option N/A	

2 SELECT A FINISH

"C" Comp

METAL FINISHES

MFB	-	-	Black (Premium Finish)
MFS	-	-	Silver
MFW	-	-	White (Premium Finish)

3 SELECT AN EDGE

Edge Profile
Option Not Available

5 OPTIONS

- PREMIUM FINISH OPTION**
- MFB: Black metal finish - \$95 per leg
 - MFW: White metal finish - \$95 per leg
- WIRE MANAGEMENT**
- W17: Wire management cover - \$55
Attaches to the leg by magnets

4 SELECT HARDWARE

Hardware
Option Not Available

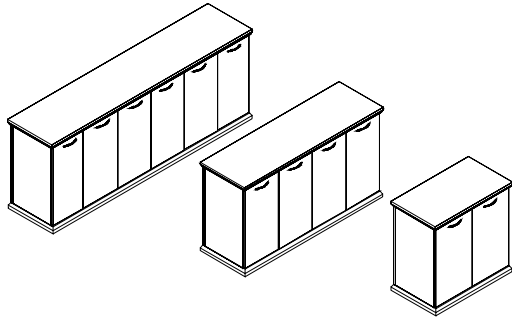

CONFERENCE STORAGE CREDENZA

STANDARD FEATURES

- Adjustable glides
- "M" styles have finished adjustable shelf behind door set
- Transitional - Hardwood base 2 1/2" H
- "W"/"G" styles have black adjustable shelf behind door set

ganged unit

NOTES

- Ganging: For end to end ganging, specify ganging flush cut modification for each

[CLICK HERE TO VIEW PRODUCT INDEX](#)

1 SELECT A STYLE

DIMENSIONS		STYLE NUMBER	LIST PRICE	STYLE NUMBER	LIST PRICE	STYLE NUMBER	LIST PRICE
W" x D" x H"	WGT	"W" Veneer Top Veneer Chassis		"G" HPL High Pressure Laminate Top Veneer Chassis		"M" TFL Thermally Fused Laminate Top Thermally Fused Laminate Chassis	
Triple Storage							
94 x 24 x 36	390	CAP9424CA124W	5324	CAP9424CA124G	5324	CAP9424CA124M	3210
88 x 24 x 36	340	CAP8824CA124W	5211	CAP8824CA124G	5211	CAP8824CA124M	2995
Double Storage							
71 x 24 x 36	290	CAP7124CA124W	3711	CAP7124CA124G	3711	CAP7124CA124M	2445
65 x 24 x 36	260	CAP6524CA124W	3587	CAP6524CA124G	3587	CAP6524CA124M	2400
59 x 24 x 36	245	CAP5924CA124W	3463	CAP5924CA124G	3463	CAP5924CA124M	2355
48 x 24 x 36	200	CAP4824CA124W	3212	CAP4824CA124G	3212	CAP4824CA124M	2265
Single Storage							
36 x 24 x 36	150	CAP3624CA124W	2088	CAP3624CA124G	2088	CAP3624CA124M	1330
30 x 24 x 36	135	CAP3024CA124W	1964	CAP3024CA124G	1964	CAP3024CA124M	1290

2 SELECT A FINISH

"W" Veneer	"G" HPL	"M" TFL	
WAC	GAC	-	Amber Cherry
WRC	-	-	Caramel Cherry
WIC	GIC	-	Crimson Cherry
WEC	-	-	Ebony Cherry
WHC	GHC	MHC	Honey Cherry
WOC	GOC	-	Koko Cherry
WSC	-	-	Scotch Cherry
WEW	GEW	-	Executive Walnut
WRW	GRW	-	Gray Luster Walnut
WGW	-	MGW	Gunstock Walnut
WJW	-	-	Judicial Walnut
WNW	GNW	-	Natural Walnut
WTW	GTW	-	Studio Teak Walnut

3 SELECT AN EDGE



4 SELECT HARDWARE

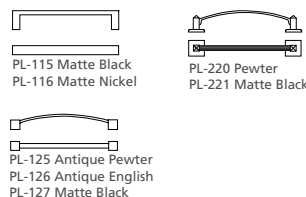

5 OPTIONS

ACCESSORIES

- REF-01: Modify Storage section for refrigerator - \$195

AUDIO VISUAL

- AVR1: AV Exhaust Fan - \$450
- AVR2: AV Pullout Rack - \$1590

BACK PANEL WALL ACCESS

- M19: 2 Heat vent/cord access slots in back - \$ 150

DOOR

- D2: Wood Door Lock - \$95 per Door Set
- D6A: "W"/"G" Styles - Delete Doors and replace black laminate shelf with finished shelf - n/c

FLUSH CUT

- FC-B: Flush Unit Both Sides(Facing) for Ganging - \$95
- FC-L: Flush Unit Left (Facing) for Ganging - \$95
- FC-R: Flush Unit Right(Facing) for Ganging - \$95

OPEN PLAN

- OPB: W "G" Style - Modify Unit for Open Plan Application - \$195
- OPB: "M" Style - Modify Unit for Open Plan Application - \$95

TRASH CAN

- TRC50: EZ Cargo 50 dual trash can - (1) 8 gallon and (1) 5 gallon - \$650

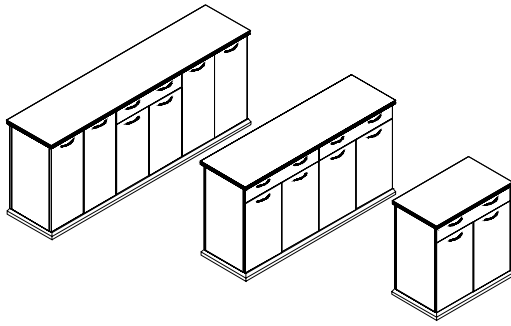

CONFERRING BUFFET CREDENZA

STANDARD FEATURES

- Adjustable glides
- "M" styles have finished adjustable shelf behind door set
- Transitional - Hardwood base 2 1/2" H
- Utility drawer w/ felt liner
- "W"/"G" styles have black adjustable shelf behind door set

ganging flush cut modification for each ganged unit

NOTES

- Ganging: For end to end ganging, specify

[CLICK HERE TO VIEW PRODUCT INDEX](#)

1 SELECT A STYLE

DIMENSIONS		STYLE NUMBER	LIST PRICE	STYLE NUMBER	LIST PRICE	STYLE NUMBER	LIST PRICE
W" x D" x H"	WGT	"W" Veneer Veneer Top Veneer Chassis		"G" HPL High Pressure Laminate Top Veneer Chassis		"M" TFL Thermally Fused Laminate Top Thermally Fused Laminate Chassis	
Triple Buffet							
94 x 24 x 36	390	CAP9424CA126W	5836	CAP9424CA126G	5836	CAP9424CA126M	3580
Double Buffet							
71 x 24 x 36	300	CAP7124CA126W	4836	CAP7124CA126G	4836	CAP7124CA126M	2810
Single Buffet							
36 x 24 x 36	175	CAP3624CA126W	2653	CAP3624CA126G	2653	CAP3624CA126M	1515

2 SELECT A FINISH

"W" Veneer	"G" HPL	"M" TFL	
WAC	GAC	-	Amber Cherry
WRC	-	-	Caramel Cherry
WIC	GIC	-	Crimson Cherry
WEC	-	-	Ebony Cherry
WHC	GHC	MHC	Honey Cherry
WOC	GOC	-	Koko Cherry
WSC	-	-	Scotch Cherry
WEW	GEW	-	Executive Walnut
WRW	GRW	-	Gray Luster Walnut
WGW	-	MGW	Gunstock Walnut
WJW	-	-	Judicial Walnut
WNW	GNW	-	Natural Walnut
WTW	GTW	-	Studio Teak Walnut

3 SELECT AN EDGE



5 OPTIONS

DOOR

- D2: Wood Door Lock - \$95 per Door Set
- D6A: "W"/"G" Styles - Delete Doors and replace black laminate shelf with finished shelf - n/c

FLUSH CUT

- FC-B: Flush Unit Both Sides(Facing) for Ganging - \$95
- FC-L: Flush Unit Left (Facing) for Ganging - \$95
- FC-R: Flush Unit Right(Facing) for Ganging - \$95

OPEN PLAN

- OPB: "W" "G" Style - Modify Unit for Open Plan Application - \$195
- OPBM: "M" Style - Modify Unit for Open Plan Application - \$95

TRASH CAN

- TRC50: EZ Cargo 50 dual trash can - (1) 8 gallon and (1) 5 gallon - \$650

4 SELECT HARDWARE

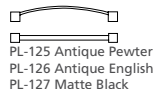
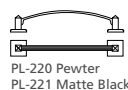
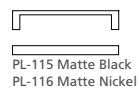

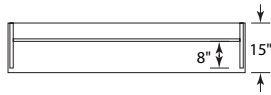
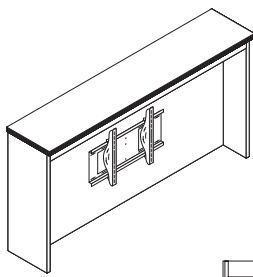

TRANSITIONAL FLAT SCREEN OVERHEAD SUPPORT

STANDARD FEATURES

- Back has (2) cable access cutouts
- Top with profile edges
- Universal flat screen mount bracket

[CLICK HERE TO VIEW PRODUCT INDEX](#)

1 SELECT A STYLE

DIMENSIONS		STYLE NUMBER	LIST PRICE	STYLE NUMBER	LIST PRICE	STYLE NUMBER	LIST PRICE
W" x D" x H"	WGT	"W" Veneer Top Veneer Chassis		"G" HPL High Pressure Laminate Top Veneer Chassis		"M"	
71 x 15 x 36	130	CAP7136OH573W	2219	"G" Option N/A		CAP7136OH573M	1305
65 x 15 x 36	120	CAP6536OH573W	2159	"G" Option N/A		CAP6536OH573M	1255
59 x 15 x 36	110	CAP5936OH573W	2093	"G" Option N/A		CAP5936OH573M	1205
48 x 15 x 36	100	CAP4836OH573W	2035	"G" Option N/A		CAP4836OH573M	1130
36 x 15 x 36	90	CAP3636OH573W	1939	"G" Option N/A		CAP3636OH573M	1035

2 SELECT A FINISH

"W" Veneer	"G" HPL	"M"	
WAC	-	-	Amber Cherry
WRC	-	-	Caramel Cherry
WIC	-	-	Crimson Cherry
WEC	-	-	Ebony Cherry
WHC	-	MHC	Honey Cherry
WOC	-	-	Koko Cherry
WSC	-	-	Scotch Cherry
WEW	-	-	Executive Walnut
WRW	-	-	Gray Luster Walnut
WGW	-	MGW	Gunstock Walnut
WJW	-	-	Judicial Walnut
WNW	-	-	Natural Walnut
WTW	-	-	Studio Teak Walnut

3 SELECT AN EDGE



5 OPTIONS

- FLUSH CUT**
- FC-B: Flush Unit Both Sides(Facing) for Ganging - \$95
 - FC-L: Flush Unit Left (Facing) for Ganging - \$95
 - FC-R: Flush Unit Right(Facing) for Ganging - \$95

4 SELECT HARDWARE

Hardware Option Not Available

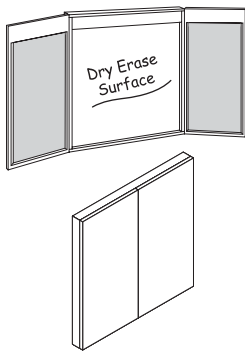

VISUAL BOARD

STANDARD FEATURES

- Built-in wall levelers
- Doors are 1" thick
- Fabric tack surface on doors (spinel sandstone)
- Finger pull at bottom
- White dry marker surface

[CLICK HERE TO VIEW PRODUCT INDEX](#)

1 SELECT A STYLE

DIMENSIONS		STYLE NUMBER	LIST PRICE	STYLE NUMBER	LIST PRICE	STYLE NUMBER	LIST PRICE
W" x D" x H"	WGT	"W" Veneer Top Veneer Chassis		"G" HPL High Pressure Laminate Top Veneer Chassis		"M" TFL Thermally Fused Laminate Top Thermally Fused Laminate Chassis	
48 x 4 x 48	130	CAP4848VB475W	2969	"G" Option N/A		CAP4848VB475M	1350
36 x 4 x 48	120	CAP3648VB475W	2344	"G" Option N/A		CAP3648VB475M	1290
48 x 4 x 36	120	CAP4836VB475W	2718	"G" Option N/A		CAP4836VB475M	1305
36 x 4 x 36	110	CAP3636VB475W	2093	"G" Option N/A		CAP3636VB475M	1245

2 SELECT A FINISH

"W" Veneer	"G" HPL	"M" TFL	
WAC	-	-	Amber Cherry
WRC	-	-	Caramel Cherry
WIC	-	-	Crimson Cherry
WEC	-	-	Ebony Cherry
WHC	-	MHC	Honey Cherry
WOC	-	-	Koko Cherry
WSC	-	-	Scotch Cherry
WEW	-	-	Executive Walnut
WRW	-	-	Gray Luster Walnut
WGW	-	MGW	Gunstock Walnut
WJW	-	-	Judicial Walnut
WNW	-	-	Natural Walnut
WTW	-	-	Studio Teak Walnut

3 SELECT AN EDGE

Edge Profile
Option Not Available

5 OPTIONS

- ACCESSORIES**
- DMKIT: Dry market kit for visual board - \$45
 - DMRT01: Replace fabric panels with dry marker/erase board - \$95
 - FC20: Flip Chart 34" x 20" - \$55 each

4 SELECT HARDWARE

Hardware
Option Not Available

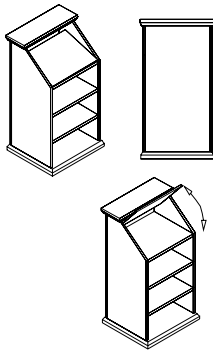

TRANSITIONAL LECTERN

STANDARD FEATURES

- 2 Adjustable shelves
- 2-1/2" Hardwood base
- Front wheels/casters for easy relocation
- Lectern surface tilts up for storage
- Molding (approach only)

[CLICK HERE TO VIEW PRODUCT INDEX](#)

1 SELECT A STYLE

DIMENSIONS		STYLE NUMBER	LIST PRICE	STYLE NUMBER	LIST PRICE	STYLE NUMBER	LIST PRICE
W" x D" x H"	WGT	"W" Veneer Top Veneer Chassis		"G" High Pressure Laminate Top HPL Veneer Chassis		"M" Thermally Fused Laminate Top TFL Thermally Fused Laminate Chassis	
24 x 24 x 46	130	CAP2424LC497W	2700	"G" Option N/A		CAP2424LC497M	1425

2 SELECT A FINISH

"W" Veneer	"G" HPL	"M" TFL	
WAC	-	-	Amber Cherry
WRC	-	-	Caramel Cherry
WIC	-	-	Crimson Cherry
WEC	-	-	Ebony Cherry
WHC	-	MHC	Honey Cherry
WOC	-	-	Koko Cherry
WSC	-	-	Scotch Cherry
WEW	-	-	Executive Walnut
WRW	-	-	Gray Luster Walnut
WGW	-	MGW	Gunstock Walnut
WJW	-	-	Judicial Walnut
WNW	-	-	Natural Walnut
WTW	-	-	Studio Teak Walnut

3 SELECT AN EDGE

Edge Profile
Option Not Available

5 OPTIONS

CASTERS
- CAS20L: Casters - \$190

4 SELECT HARDWARE

Hardware
Option Not Available

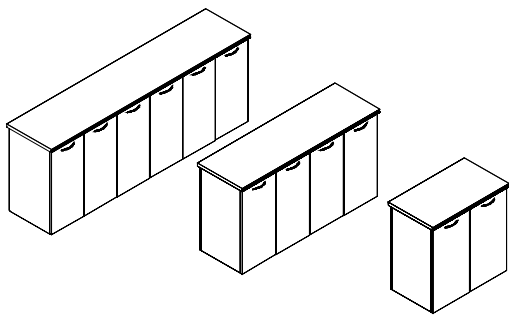

CONFERRING STORAGE CREDENZA

STANDARD FEATURES

- Adjustable glides
- "M" styles shelves match finish
- "W"/"G" styles have black adjustable shelf behind door set

NOTES

- All units are std with flush ends

[CLICK HERE TO VIEW PRODUCT INDEX](#)

1 SELECT A STYLE

DIMENSIONS		STYLE NUMBER	LIST PRICE	STYLE NUMBER	LIST PRICE	STYLE NUMBER	LIST PRICE
W" x D" x H"	WGT	"W" Veneer Veneer Top Veneer Chassis		"G" HPL High Pressure Laminate Top Veneer Chassis		"M" TFL Thermally Fused Laminate Top Thermally Fused Laminate Chassis	
Triple Storage							
93 x 24 x 36	390	CPC9324CA124W	5187	CPC9324CA124G	5187	CPC9324CA124M	2995
87 x 24 x 36	340	CPC8724CA124W	5054	CPC8724CA124G	5054	CPC8724CA124M	2775
Double Storage							
70 x 24 x 36	290	CPC7024CA124W	3579	CPC7024CA124G	3579	CPC7024CA124M	2290
64 x 24 x 36	260	CPC6424CA124W	3446	CPC6424CA124G	3446	CPC6424CA124M	2245
58 x 24 x 36	245	CPC5824CA124W	3247	CPC5824CA124G	3247	CPC5824CA124M	2200
47 x 24 x 36	200	CPC4724CA124W	3114	CPC4724CA124G	3114	CPC4724CA124M	2110
Single Storage							
35 x 24 x 36	150	CPC3524CA124W	1972	CPC3524CA124G	1972	CPC3524CA124M	1240
29 x 24 x 36	135	CPC2924CA124W	1837	CPC2924CA124G	1837	CPC2924CA124M	1200

2 SELECT A FINISH

"W" Veneer	"G" HPL	"M" TFL	
WAC	GAC	-	Amber Cherry
WRC	-	-	Caramel Cherry
WIC	GIC	-	Crimson Cherry
WEC	-	-	Ebony Cherry
WHC	GHC	MHC	Honey Cherry
WOC	GOC	MOC	KoKo Cherry
WSC	-	-	Scotch Cherry
WAM	GAM	-	Alabaster Maple
WCM	GCM	-	Clear Maple
WWM	GWM	-	Wheat Maple
WEW	GEW	-	Executive Walnut
WRW	GRW	-	Gray Luster Walnut
WGW	-	MGW	Gunstock Walnut
WJW	-	-	Judicial Walnut
WNW	GNW	-	Natural Walnut
WTW	GTW	MTW	Studio Teak Walnut
WWP	GWL	MWL	Designer White

3 SELECT AN EDGE

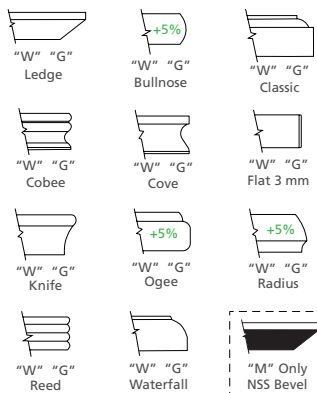

5 OPTIONS

- ACCESSORIES**
- REF-01: Modify Storage section for refrigerator - \$195
- AUDIO VISUAL**
- AVR1: AV Exhaust Fan - \$450
- AVR2: AV Pullout Rack - \$1590
- BACK PANEL WALL ACCESS**
- M19: 2 Heat vent/cord access slots in back - \$ 150
- DOOR**
- D2: Wood Door Lock - \$95 per Door Set
- D6A: "W"/"G" Styles - Delete Doors and replace black laminate shelf with finished shelf - n/c
- OPEN PLAN**
- OPB: "W" "G" Style - Modify Unit for Open Plan Application - \$195
- OPB: "M" Style - Modify Unit for Open Plan Application - \$95
- SHELF**
- S25: Replace Black Laminate Shelf with Finished Shelf - \$75 per Shelf
- TRASH CAN**
- TRC50: EZ Cargo 50 dual trash can - (1) 8 gallon and (1) 5 gallon - \$650

4 SELECT HARDWARE

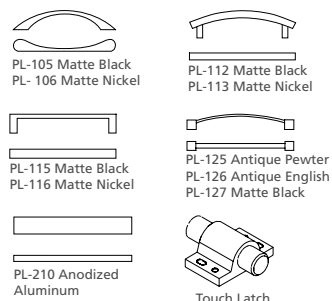

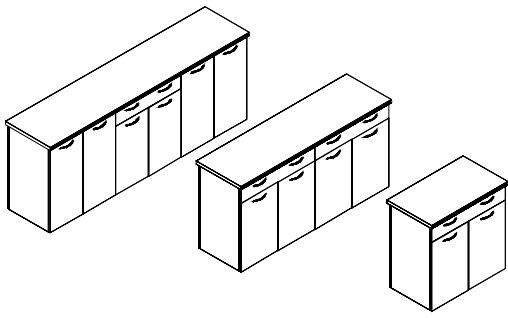

CONFERRING BUFFET CREDEENZA

STANDARD FEATURES

- "M" styles have finished adjustable shelf behind door set
- Adjustable glides
- Full extension drawers - locking
- "W"/"G" styles have black adjustable shelf behind door set
- Utility drawer w/ felt liner

NOTES

- All units are std with flush ends

[CLICK HERE TO VIEW PRODUCT INDEX](#)

1 SELECT A STYLE

DIMENSIONS		STYLE NUMBER	LIST PRICE	STYLE NUMBER	LIST PRICE	STYLE NUMBER	LIST PRICE
W" x D" x H"	WGT	"W" Veneer Top Veneer Chassis		"G" HPL High Pressure Laminate Top Veneer Chassis		"M" TFL Thermally Fused Laminate Top Thermally Fused Laminate Chassis	
Triple Buffet							
93 x 24 x 36	390	CPC9324CA126W	5723	CPC9324CA126G	5723	CPC9324CA126M	3360
Double Buffet							
70 x 24 x 36	300	CPC7024CA126W	4652	CPC7024CA126G	4652	CPC7024CA126M	2655
Single Buffet							
35 x 24 x 36	175	CPC3524CA126W	2584	CPC3524CA126G	2584	CPC3524CA126M	1425

2 SELECT A FINISH

"W" Veneer	"G" HPL	"M" TFL	
WAC	GAC	-	Amber Cherry
WRC	-	-	Caramel Cherry
WIC	GIC	-	Crimson Cherry
WEC	-	-	Ebony Cherry
WHC	GHC	MHC	Honey Cherry
WOC	GOC	MOC	KoKo Cherry
WSC	-	-	Scotch Cherry
WAM	GAM	-	Alabaster Maple
WCM	GCM	-	Clear Maple
WWM	GWM	-	Wheat Maple
WEW	GEW	-	Executive Walnut
WRW	GRW	-	Gray Luster Walnut
WGW	-	MGW	Gunstock Walnut
WJW	-	-	Judicial Walnut
WNW	GNW	-	Natural Walnut
WTW	GTW	MTW	Studio Teak Walnut
WWP	GWL	MWL	Designer White

3 SELECT AN EDGE

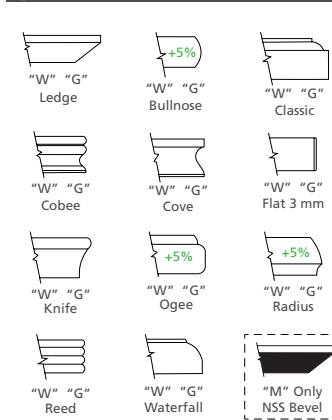

4 SELECT HARDWARE

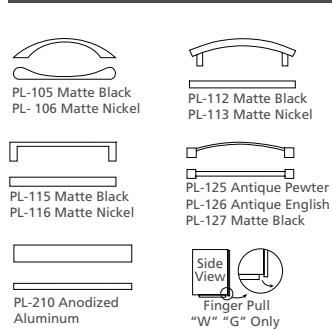

5 OPTIONS

- ACCESSORIES**
- REF-01: Modify Storage section for refrigerator - \$195
 - Option is available on 93 x 24 x 36
- DOOR**
- D2: Wood Door Lock - \$95 per Door Set
 - D6A: "W"/"G" Styles - Delete Doors and replace black laminate shelf with finished shelf - n/c
- OPEN PLAN**
- OPB: "W" "G" Style - Modify Unit for Open Plan Application - \$195
 - OPB: "M" Style - Modify Unit for Open Plan Application - \$95
- TRASH CAN**
- TRC50: EZ Cargo 50 dual trash can - (1) 8 gallon and (1) 5 gallon - \$650

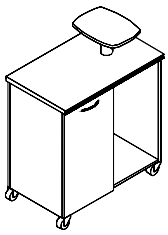

MOBILE MEDIA CART

STANDARD FEATURES

- Cable storage hooks
- Full extension drawers - locking silver casters
- Open kneespace w/ adjustable shelf
- Platform 12 x 16 height adjustable
- Storage cabinet w/ shelf

[CLICK HERE TO VIEW PRODUCT INDEX](#)

1 SELECT A STYLE

DIMENSIONS		STYLE NUMBER	LIST PRICE	STYLE NUMBER	LIST PRICE	STYLE NUMBER	LIST PRICE
W" x D" x H"	WGT	"W" Veneer Top Veneer Chassis		"G" HPL High Pressure Laminate Top Veneer Chassis		"M" TFL Thermally Fused Laminate Top Thermally Fused Laminate Chassis	
35 x 24 x 37/45	175	CPC3524MC517W	2240	"G" Option N/A		CPC3524MC517M	1725

2 SELECT A FINISH

"W" Veneer	"G" HPL	"M" TFL	
WAC	-	-	Amber Cherry
WRC	-	-	Caramel Cherry
WIC	-	-	Crimson Cherry
WEC	-	-	Ebony Cherry
WHC	-	MHC	Honey Cherry
WOC	-	MOC	KoKo Cherry
WSC	-	-	Scotch Cherry
WAM	-	-	Alabaster Maple
WCM	-	-	Clear Maple
WWM	-	-	Wheat Maple
WEW	-	-	Executive Walnut
WRW	-	-	Gray Luster Walnut
WGW	-	MGW	Gunstock Walnut
WJW	-	-	Judicial Walnut
WNW	-	-	Natural Walnut
WTW	-	MTW	Studio Teak Walnut
WWP	-	MWL	Designer White

3 SELECT AN EDGE

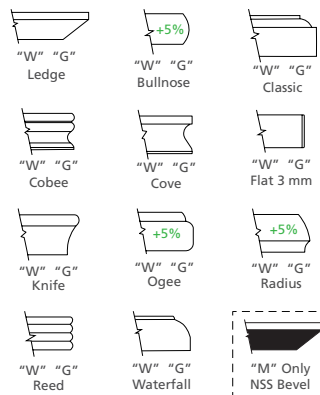

4 SELECT HARDWARE

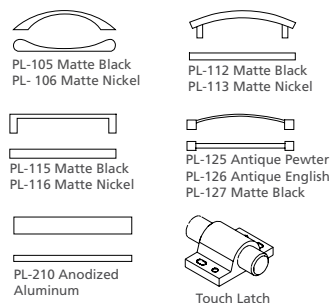

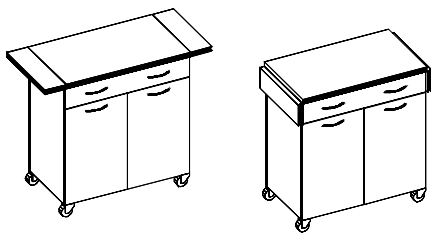

MOBILE EXTENSION BUFFET CART

STANDARD FEATURES

- (2) TM50 grommets in backpanel
- Flat/Flush ends
- Hinged top extensions
- Full extension drawers - locking silver casters
- Open storage & closed cabinet w/ grommet

[CLICK HERE TO VIEW PRODUCT INDEX](#)

1 SELECT A STYLE

DIMENSIONS		STYLE NUMBER	LIST PRICE	STYLE NUMBER	LIST PRICE	STYLE NUMBER	LIST PRICE
W" x D" x H"	WGT	"W" Veneer Top Veneer Veneer Chassis		"G" High Pressure Laminate Top HPL Veneer Chassis		"M" Thermally Fused Laminate Top TFL Thermally Fused Laminate Chassis	
35 x 24 x 36	170	CPC3524SC483W	2374	"G" Option N/A		CPC3524SC483M	1625

2 SELECT A FINISH

"W"	"G"	"M"	
Veneer	HPL	TFL	
WAC	-	-	Amber Cherry
WRC	-	-	Caramel Cherry
WIC	-	-	Crimson Cherry
WEC	-	-	Ebony Cherry
WHC	-	MHC	Honey Cherry
WOC	-	MOC	KoKo Cherry
WSC	-	-	Scotch Cherry
WAM	-	-	Alabaster Maple
WCM	-	-	Clear Maple
WWM	-	-	Wheat Maple
WEW	-	-	Executive Walnut
WRW	-	-	Gray Luster Walnut
WGW	-	MGW	Gunstock Walnut
WJW	-	-	Judicial Walnut
WNW	-	-	Natural Walnut
WTW	-	MTW	Studio Teak Walnut
WWP	-	MWL	Designer White

3 SELECT AN EDGE

Edge Profile
Option Not Available

5 OPTIONS

4 SELECT HARDWARE

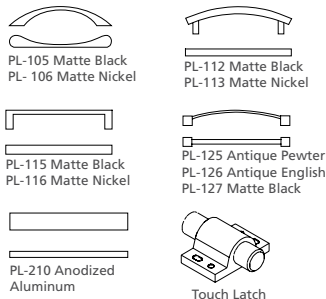

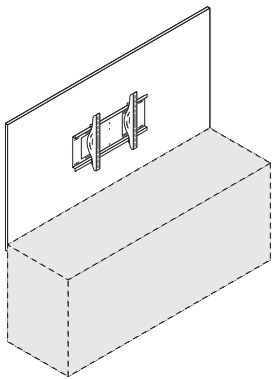

FLAT SCREEN WALL HUNG PANEL

STANDARD FEATURES

- 1.25" thick panel
- Back has (2) cable access cutouts
- Universal flat screen mount bracket

[CLICK HERE TO VIEW PRODUCT INDEX](#)

1 SELECT A STYLE

DIMENSIONS		STYLE NUMBER	LIST PRICE	STYLE NUMBER	LIST PRICE	STYLE NUMBER	LIST PRICE
"W" x "D" x "H"	WGT	"W" Veneer Veneer Top Veneer Chassis		"G" HPL High Pressure Laminate Top Veneer Chassis		"M"	
70 x 4 x 38	100	CPC7038WH575W	1219	"G" Option N/A		CPC7038WH575M	900
64 x 4 x 38	90	CPC6438WH575W	1196	"G" Option N/A		CPC6438WH575M	870
58 x 4 x 38	80	CPC5838WH575W	1166	"G" Option N/A		CPC5838WH575M	840
47 x 4 x 38	65	CPC4738WH575W	1095	"G" Option N/A		CPC4738WH575M	780
35 x 4 x 38	50	CPC3538WH575W	1042	"G" Option N/A		CPC3538WH575M	725

2 SELECT A FINISH **3 SELECT AN EDGE** **5 OPTIONS**

"W" Veneer	"G" HPL	"M"	
WAC	-	-	Amber Cherry
WRC	-	-	Caramel Cherry
WIC	-	-	Crimson Cherry
WEC	-	-	Ebony Cherry
WHC	-	MHC	Honey Cherry
WOC	-	MOC	KoKo Cherry
WSC	-	-	Scotch Cherry
WAM	-	-	Alabaster Maple
WCM	-	-	Clear Maple
WWM	-	-	Wheat Maple
WEW	-	-	Executive Walnut
WRW	-	-	Gray Luster Walnut
WGW	-	MGW	Gunstock Walnut
WJW	-	-	Judicial Walnut
WNW	-	-	Natural Walnut
WTW	-	MTW	Studio Teak Walnut
WWP	-	MWL	Designer White

Edge Profile
Option Not Available

4 SELECT HARDWARE

Hardware
Option Not Available

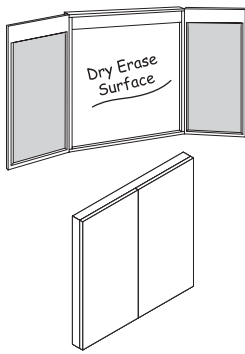

VISUAL BOARD

STANDARD FEATURES

- Built-in wall levelers
- Doors are 1" thick
- Fabric tack surface on doors (spinel sandstone)
- Finger pull at bottom
- White dry marker surface

[CLICK HERE TO VIEW PRODUCT INDEX](#)

1 SELECT A STYLE

DIMENSIONS		STYLE NUMBER	LIST PRICE	STYLE NUMBER	LIST PRICE	STYLE NUMBER	LIST PRICE
W" x D" x H"	WGT	"W" Veneer Top Veneer Chassis		"G" HPL High Pressure Laminate Top Veneer Chassis		"M" TFL Thermally Fused Laminate Top Thermally Fused Laminate Chassis	
48 x 4 x 48	130	CPC4848VB475W	2670	"G" Option N/A		CPC4848VB475M	1275
36 x 4 x 48	120	CPC3648VB475W	2480	"G" Option N/A		CPC3648VB475M	1230
48 x 4 x 36	120	CPC4836VB475W	2480	"G" Option N/A		CPC4836VB475M	1230
36 x 4 x 36	110	CPC3636VB475W	2155	"G" Option N/A		CPC3636VB475M	1185

2 SELECT A FINISH

"W" Veneer	"G" HPL	"M" TFL	
WAC	-	-	Amber Cherry
WRC	-	-	Caramel Cherry
WIC	-	-	Crimson Cherry
WEC	-	-	Ebony Cherry
WHC	-	MHC	Honey Cherry
WOC	-	MOC	KoKo Cherry
WSC	-	-	Scotch Cherry
WAM	-	-	Alabaster Maple
WCM	-	-	Clear Maple
WWM	-	-	Wheat Maple
WEW	-	-	Executive Walnut
WRW	-	-	Gray Luster Walnut
WGW	-	MGW	Gunstock Walnut
WJW	-	-	Judicial Walnut
WNW	-	-	Natural Walnut
WTW	-	MTW	Studio Teak Walnut
WWP	-	MWL	Designer White

3 SELECT AN EDGE

Edge Profile
Option Not Available

5 OPTIONS

ACCESSORIES

- DMKIT: Dry market kit for visual board - \$45
- DMRT01: Replace fabric panels with dry marker/erase board - \$95
- FC20: Flip Chart 34" x 20" - \$55 each

4 SELECT HARDWARE

Hardware
Option Not Available

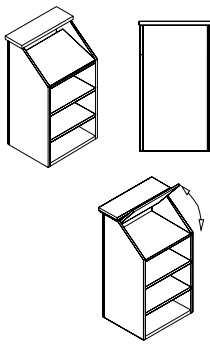

LECTERN

STANDARD FEATURES

- 2 Adjustable shelves
- Front wheels/casters for easy relocation
- Lectern surface tilts up for storage

[CLICK HERE TO VIEW PRODUCT INDEX](#)

1 SELECT A STYLE

DIMENSIONS		STYLE NUMBER	LIST PRICE	STYLE NUMBER	LIST PRICE	STYLE NUMBER	LIST PRICE
W" x D" x H"	WGT	"W" Veneer Top Veneer Chassis		"G" High Pressure Laminate Top HPL Veneer Chassis		"M" Thermally Fused Laminate Top TFL Thermally Fused Laminate Chassis	
24 x 24 x 46	130	CPC2424LC499W	2500	"G" Option N/A		CPC2424LC499M--With tilt shelf	1225

2 SELECT A FINISH

"W" Veneer	"G" HPL	"M" TFL	
WAC	-	-	Amber Cherry
WRC	-	-	Caramel Cherry
WIC	-	-	Crimson Cherry
WEC	-	-	Ebony Cherry
WHC	-	MHC	Honey Cherry
WOC	-	MOC	KoKo Cherry
WSC	-	-	Scotch Cherry
WAM	-	-	Alabaster Maple
WCM	-	-	Clear Maple
WWM	-	-	Wheat Maple
WEW	-	-	Executive Walnut
WRW	-	-	Gray Luster Walnut
WGW	-	MGW	Gunstock Walnut
WJW	-	-	Judicial Walnut
WNW	-	-	Natural Walnut
WTW	-	MTW	Studio Teak Walnut
WWP	-	MWL	Designer White

3 SELECT AN EDGE

Edge Profile
Option Not Available

5 OPTIONS

CASTERS
- CAS20L: Casters - \$190

4 SELECT HARDWARE

Hardware
Option Not Available

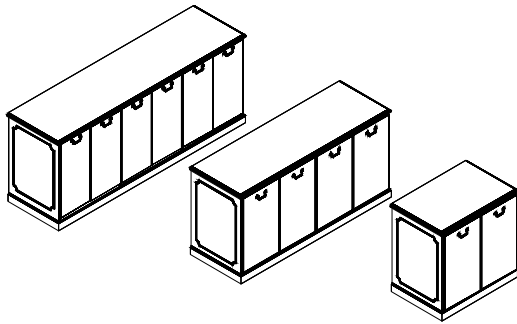

CONFERENCE STORAGE CREDENZA

STANDARD FEATURES

- Each section has wood adjustable shelf

[CLICK HERE TO VIEW PRODUCT INDEX](#)

1 SELECT A STYLE

DIMENSIONS		STYLE NUMBER	LIST PRICE	STYLE NUMBER	LIST PRICE	STYLE NUMBER	LIST PRICE
W" x D" x H"	WGT	"W" Veneer Top Veneer Chassis		"G" HPL High Pressure Laminate Top Veneer Chassis		"M" TFL Thermally Fused Laminate Top Thermally Fused Laminate Chassis	
Triple Storage							
95 x 24 x 36	390	JCM9524CA124W	6222	JCM9524CA124G	6222	"M" Option N/A	
89 x 24 x 36	340	JCM8924CA124W	5922	JCM8924CA124G	5922	"M" Option N/A	
Double Storage							
72 x 24 x 36	260	JCM7224CA124W	4674	JCM7224CA124G	4674	"M" Option N/A	
66 x 24 x 36	260	JCM6624CA124W	4523	JCM6624CA124G	4523	"M" Option N/A	
60 x 24 x 36	245	JCM6024CA124W	4373	JCM6024CA124G	4373	"M" Option N/A	
48 x 24 x 36	200	JCM4824CA124W	4074	JCM4824CA124G	4074	"M" Option N/A	
Single Storage							
37 x 24 x 36	130	JCM3724CA124W	2385	JCM3724CA124G	2385	"M" Option N/A	
31 x 24 x 36	135	JCM3124CA124W	2231	JCM3124CA124G	2231	"M" Option N/A	

2 SELECT A FINISH

"W" Veneer	"G" HPL	"M" TFL	
WAC	GAC	-	Amber Cherry
WRC	-	-	Caramel Cherry
WIC	GIC	-	Crimson Cherry
WEC	-	-	Ebony Cherry
WHC	GHC	-	Honey Cherry
WOC	GOC	-	KoKo Cherry
WSC	-	-	Scotch Cherry
WEW	GEW	-	Executive Walnut
WRW	GRW	-	Gray Luster Walnut
WGW	-	-	Gunstock Walnut
WJW	-	-	Judicial Walnut
WNW	GNW	-	Natural Walnut
WTW	GTW	-	Studio Teak Walnut

3 SELECT AN EDGE



Traditional

5 OPTIONS

ACCESSORIES

- REF-01: Modify Storage section for refrigerator - \$195

AUDIO VISUAL

- AVR1: AV Exhaust Fan - \$450
 - AVR2: AV Pullout Rack - \$1590

BACK PANEL WALL ACCESS

- M19: 2 Heat vent/cord access slots in back - \$ 150

DOOR

- D2: Wood Door Lock - \$95 per Door Set
 - D6: Delete doors - n/c

FLUSH CUT

- FC-B: Flush Unit Both Sides(Facing) for Ganging - \$95
 - FC-L: Flush Unit Left (Facing) for Ganging - \$95
 - FC-R: Flush Unit Right(Facing) for Ganging - \$95

OPEN PLAN

- OPB: "W" "G" Style - Modify Unit for Open Plan Application - \$295

TRASH CAN

- TRC50: EZ Cargo 50 dual trash can - (1) 8 gallon and (1) 5 gallon - \$650

4 SELECT HARDWARE



PL-4 Antique Brass



PL-5 Antique Brass
 PL- 50 Brushed Pewter

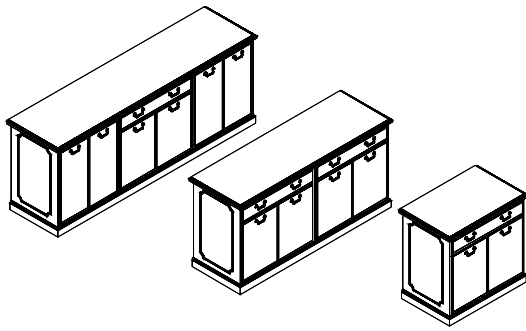

CONFERENCE BUFFET CREDENZA

STANDARD FEATURES

- Adjustable wood shelf per section
- Utility drawer w/ felt liner

[CLICK HERE TO VIEW PRODUCT INDEX](#)

1 SELECT A STYLE

DIMENSIONS		STYLE NUMBER	LIST PRICE	STYLE NUMBER	LIST PRICE	STYLE NUMBER	LIST PRICE
W" x D" x H"	WGT	"W" Veneer Top Veneer Chassis		"G" HPL High Pressure Laminate Top Veneer Chassis		"M" TFL Thermally Fused Laminate Top Thermally Fused Laminate Chassis	
Triple Buffet							
95 x 24 x 36	400	JCM9524CA126W	6996	JCM9524CA126G	6996	"M" Option N/A	
Double Buffet							
72 x 24 x 36	300	JCM7224CA126W	5342	JCM7224CA126G	5342	"M" Option N/A	
Single Buffet							
37 x 24 x 36	150	JCM3724CA126W	2788	JCM3724CA126G	2788	"M" Option N/A	

2 SELECT A FINISH

"W" Veneer	"G" HPL	"M" TFL	
WAC	GAC	-	Amber Cherry
WRC	-	-	Caramel Cherry
WIC	GIC	-	Crimson Cherry
WEC	-	-	Ebony Cherry
WHC	GHC	-	Honey Cherry
WOC	GOC	-	KoKo Cherry
WSC	-	-	Scotch Cherry
WEW	GEW	-	Executive Walnut
WRW	GRW	-	Gray Luster Walnut
WGW	-	-	Gunstock Walnut
WJW	-	-	Judicial Walnut
WNW	GNW	-	Natural Walnut
WTW	GTW	-	Studio Teak Walnut

3 SELECT AN EDGE



5 OPTIONS

ACCESSORIES

- REF-01: Modify Storage section for refrigerator - \$195
- Option is available on 94"

DOOR

- D6: Delete doors - n/c

FLUSH CUT

- FC-B: Flush Unit Both Sides(Facing) for Ganging - \$95
- FC-L: Flush Unit Left (Facing) for Ganging - \$95
- FC-R: Flush Unit Right(Facing) for Ganging - \$95

OPEN PLAN

- OPB: "W" "G" Style - Modify Unit for Open Plan Application - \$295

TRASH CAN

- TRC50: EZ Cargo 50 dual trash can - (1) 8 gallon and (1) 5 gallon - \$650

4 SELECT HARDWARE



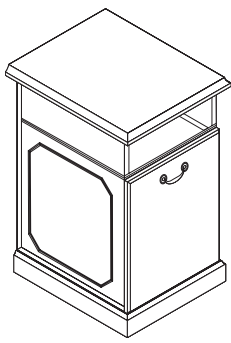

TRADITIONAL TELEPHONE CABINET

STANDARD FEATURES

- Hardwood base and moldings

[CLICK HERE TO VIEW PRODUCT INDEX](#)

1 SELECT A STYLE

DIMENSIONS		STYLE NUMBER	LIST PRICE	STYLE NUMBER	LIST PRICE	STYLE NUMBER	LIST PRICE
W" x D" x H"	WGT	"W" Veneer Top Veneer Veneer Chassis		"G" High Pressure Laminate Top HPL Veneer Chassis		"M" Thermally Fused Laminate Top TFL Thermally Fused Laminate Chassis	
16 x 22 x 29	50	JCM1622TS487W	1761	JCM1622TS487G	1761	"M" Option N/A	

2 SELECT A FINISH

"W" Veneer	"G" HPL	"M" TFL	
WAC	GAC	-	Amber Cherry
WRC	-	-	Caramel Cherry
WIC	GIC	-	Crimson Cherry
WEC	-	-	Ebony Cherry
WHC	GHC	-	Honey Cherry
WOC	GOC	-	KoKo Cherry
WSC	-	-	Scotch Cherry
WEW	GEW	-	Executive Walnut
WRW	GRW	-	Gray Luster Walnut
WGW	-	-	Gunstock Walnut
WJW	-	-	Judicial Walnut
WNW	GNW	-	Natural Walnut
WTW	GTW	-	Studio Teak Walnut

3 SELECT AN EDGE



Traditional

5 OPTIONS

FLUSH CUT

- FC-B: Flush Unit Both Sides(Facing) for Ganging - \$95
- FC-L: Flush Unit Left (Facing) for Ganging - \$95
- FC-R: Flush Unit Right(Facing) for Ganging - \$95

MOLDING

- STC01: Optional Scalloped Molding - \$100

OPEN PLAN

- OPB: "W" "G" Style - Modify Unit for Open Plan Application - \$295

4 SELECT HARDWARE



PL-4 Antique Brass



PL-5 Antique Brass
PL- 50 Brushed Pewter

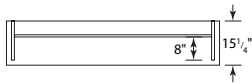
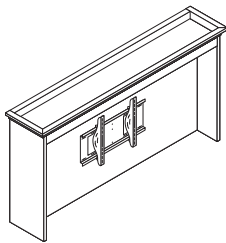

43"H Units Not For Ganging Flush Cut

TRADITIONAL FLAT SCREEN OVERHEAD SUPPORT

STANDARD FEATURES

- 1.25" thick panel
- Back has (2) cable access cutouts
- Universal flat screen mount bracket

NOTES

- Cornice adds 2.5"

[CLICK HERE TO VIEW PRODUCT INDEX](#)

1 SELECT A STYLE

DIMENSIONS		STYLE NUMBER	LIST PRICE	STYLE NUMBER	LIST PRICE	STYLE NUMBER	LIST PRICE
W" x D" x H"	WGT	"W" Veneer Top Veneer Chassis		"G" HPL High Pressure Laminate Top Veneer Chassis		"M" TFL Thermally Fused Laminate Top Thermally Fused Laminate Chassis	
70 x 15 x 36	130	JCM7036WH574W	3119	"G" Option N/A		"M" Option N/A	
64 x 15 x 36	120	JCM6436WH574W	3042	"G" Option N/A		"M" Option N/A	
58 x 15 x 36	110	JCM5836WH574W	2954	"G" Option N/A		"M" Option N/A	
47 x 15 x 36	100	JCM4736WH574W	2734	"G" Option N/A		"M" Option N/A	
35 x 15 x 36	90	JCM3536WH574W	2613	"G" Option N/A		"M" Option N/A	

2 SELECT A FINISH

"W" Veneer	"G" HPL	"M" TFL	
WAC	-	-	Amber Cherry
WRC	-	-	Caramel Cherry
WIC	-	-	Crimson Cherry
WEC	-	-	Ebony Cherry
WHC	-	-	Honey Cherry
WOC	-	-	KoKo Cherry
WSC	-	-	Scotch Cherry
WEW	-	-	Executive Walnut
WRW	-	-	Gray Luster Walnut
WGW	-	-	Gunstock Walnut
WJW	-	-	Judicial Walnut
WNW	-	-	Natural Walnut
WTW	-	-	Studio Teak Walnut

3 SELECT AN EDGE

Edge Profile
Option Not Available

5 OPTIONS

- FLUSH CUT**
- FC-B: Flush Unit Both Sides(Facing) for Ganging - \$95
 - FC-L: Flush Unit Left (Facing) for Ganging - \$95
 - FC-R: Flush Unit Right(Facing) for Ganging - \$95

4 SELECT HARDWARE

Hardware
Option Not Available

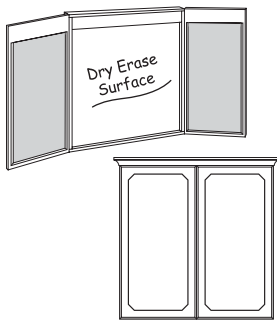

VISUAL BOARD

STANDARD FEATURES

- 1" thick doors / 3mm edge bands
- Fabric tack door panels (standard - spinel sandstone)
- Finger pull at bottom
- White dry marker back

[CLICK HERE TO VIEW PRODUCT INDEX](#)

1 SELECT A STYLE

DIMENSIONS		STYLE NUMBER	LIST PRICE	STYLE NUMBER	LIST PRICE	STYLE NUMBER	LIST PRICE
W" x D" x H"	WGT	"W" Veneer Top Veneer Chassis		"G" HPL High Pressure Laminate Top Veneer Chassis		"M" TFL Thermally Fused Laminate Top Thermally Fused Laminate Chassis	
48 x 4 x 51	150	JCM4851VB475W	3491	"G" Option N/A		"M" Option N/A	
36 x 4 x 51	140	JCM3651VB475W	3245	"G" Option N/A		"M" Option N/A	
48 x 4 x 39	140	JCM4839VB475W	3245	"G" Option N/A		"M" Option N/A	
36 x 4 x 39	130	JCM3639VB475W	2822	"G" Option N/A		"M" Option N/A	

2 SELECT A FINISH

"W" Veneer	"G" HPL	"M" TFL	
WAC	-	-	Amber Cherry
WRC	-	-	Caramel Cherry
WIC	-	-	Crimson Cherry
WEC	-	-	Ebony Cherry
WHC	-	-	Honey Cherry
WOC	-	-	KoKo Cherry
WSC	-	-	Scotch Cherry
WEW	-	-	Executive Walnut
WRW	-	-	Gray Luster Walnut
WGW	-	-	Gunstock Walnut
WJW	-	-	Judicial Walnut
WNW	-	-	Natural Walnut
WTW	-	-	Studio Teak Walnut

3 SELECT AN EDGE

Edge Profile
Option Not Available

5 OPTIONS

- ACCESSORIES**
- DMKIT: Dry market kit for visual board - \$45
 - DMRT01: Replace fabric panels with dry marker/erase board - \$95
 - FC20: Flip Chart 34" x 20" - \$55 each
 - PJ1: Pull down projection screen - \$275
 - PWB-4848: White porcelain magnetic writing board for 48 x 48 wall visual board - \$310
- MOLDING**
- DSM2: Delete molding - Deduct \$50

4 SELECT HARDWARE

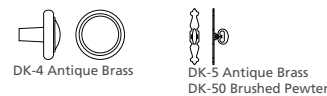

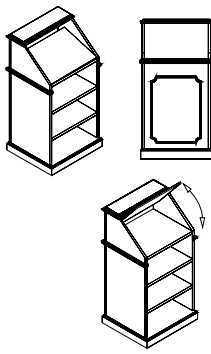

TRADITIONAL LECTERN

STANDARD FEATURES

- 2 Adjustable shelves
- 3-1/2" Hardwood base
- Front wheels/casters for easy relocation
- Lectern surface tilts up for storage
- Molding (approach only)

[CLICK HERE TO VIEW PRODUCT INDEX](#)

1 SELECT A STYLE

DIMENSIONS		STYLE NUMBER	LIST PRICE	STYLE NUMBER	LIST PRICE	STYLE NUMBER	LIST PRICE
W" x D" x H"	WGT	"W" Veneer Top Veneer Chassis		"G" HPL High Pressure Laminate Top Veneer Chassis		"M" TFL Thermally Fused Laminate Top Thermally Fused Laminate Chassis	
24 x 24 x 46	130	JCM2424LC499W	3250	"G" Option N/A		"M" Option N/A	

2 SELECT A FINISH

"W" Veneer	"G" HPL	"M" TFL	
WAC	-	-	Amber Cherry
WRC	-	-	Caramel Cherry
WIC	-	-	Crimson Cherry
WEC	-	-	Ebony Cherry
WHC	-	-	Honey Cherry
WOC	-	-	KoKo Cherry
WSC	-	-	Scotch Cherry
WEW	-	-	Executive Walnut
WRW	-	-	Gray Luster Walnut
WGW	-	-	Gunstock Walnut
WJW	-	-	Judicial Walnut
WNW	-	-	Natural Walnut
WTW	-	-	Studio Teak Walnut

3 SELECT AN EDGE

Edge Profile
Option Not Available

5 OPTIONS

CASTERS
- CAS20L: Casters - \$190

4 SELECT HARDWARE

Hardware
Option Not Available

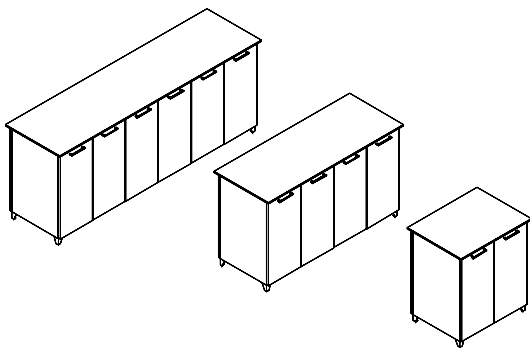

CONFERRING STORAGE CREDENZA

STANDARD FEATURES

- Adjustable glides
- "M" styles shelves match finish
- Standard Silver feet (optional White, Black)
- Storage cabinet w/ adjustable black laminate shelf
- "W"/"G" styles have black adjustable shelf

ganged unit

NOTES

- Ganging: For end to end ganging, specify ganging flush cut modification for each

[CLICK HERE TO VIEW PRODUCT INDEX](#)

1 SELECT A STYLE

DIMENSIONS		STYLE NUMBER	LIST PRICE	STYLE NUMBER	LIST PRICE	STYLE NUMBER	LIST PRICE
W" x D" x H"	WGT	"W" Veneer Veneer Top Veneer Chassis		"G" HPL High Pressure Laminate Top Veneer Chassis		"M" TFL Thermally Fused Laminate Top Thermally Fused Laminate Chassis	
Triple Storage							
95 x 24 x 36	400	NSS9524CA124W	3395	NSS9524CA124G	3395	NSS9524CA124M	3093
89 x 24 x 36	360	NSS8924CA124W	3860	NSS8924CA124G	3860	NSS8924CA124M	2875
Double Storage							
72 x 24 x 36	300	NSS7224CA124W	3350	NSS7224CA124G	3350	NSS7224CA124M	2365
66 x 24 x 36	275	NSS6624CA124W	3260	NSS6624CA124G	3260	NSS6624CA124M	2320
60 x 24 x 36	250	NSS6024CA124W	3170	NSS6024CA124G	3170	NSS6024CA124M	2276
48 x 24 x 36	200	NSS4824CA124W	2990	NSS4824CA124G	2990	NSS4824CA124M	2185
Single Storage							
37 x 24 x 36	150	NSS3724CA124W	1800	NSS3724CA124G	1800	NSS3724CA124M	1290
31 x 24 x 36	135	NSS3124CA124W	1670	NSS3124CA124G	1670	NSS3124CA124M	1250

2 SELECT A FINISH

"W" Veneer	"G" HPL	"M" TFL	
WAC	GAC	-	Amber Cherry
WRC	-	-	Caramel Cherry
WIC	GIC	-	Crimson Cherry
WEC	-	-	Ebony Cherry
WHC	GHC	MHC	Honey Cherry
WOC	GOC	MOC	KoKo Cherry
WSC	-	-	Scotch Cherry
WAM	GAM	-	Alabaster Maple
WCM	GCM	-	Clear Maple
WWM	GWM	-	Wheat Maple
WEW	GEW	-	Executive Walnut
WRW	GRW	-	Gray Luster Walnut
WGW	-	MGW	Gunstock Walnut
WJW	-	-	Judicial Walnut
WNW	GNW	-	Natural Walnut
WTW	GTW	MTW	Studio Teak Walnut
WWP	GWL	MWL	Designer White
METAL FINISHES			
MFB	-	-	Black (Premium Finish)
MFS	-	-	Silver
MFW	-	-	White (Premium Finish)

3 SELECT AN EDGE

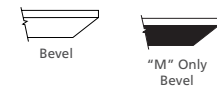

4 SELECT HARDWARE

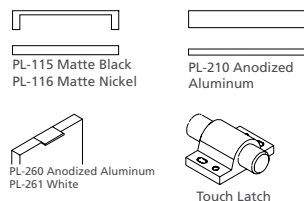

5 OPTIONS

- ACCESSORIES**
- REF-01: Modify Storage section for refrigerator - \$195
- AUDIO VISUAL**
- AVR1: AV Exhaust Fan - \$450
 - AVR2: AV Pullout Rack - \$1590
- DOOR**
- D2: Wood Door Lock - \$95 per Door Set
 - D6A: "W"/"G" Styles - Delete Doors and replace black laminate shelf with finished shelf - n/c
 - D8: Delete feet (includes extended fronts to the floor) - n/c
 - REF-01: Modify Storage section for refrigerator - \$195
- FLUSH CUT**
- FC-B: Flush Unit Both Sides(Facing) for Ganging - \$50
 - FC-L: Flush Unit Left (Facing) for Ganging - \$50
 - FC-R: Flush Unit Right(Facing) for Ganging - \$50
- OPEN PLAN**
- OPB: "W" "G" Style - Modify Unit for Open Plan Application - \$195
 - OPM: "M" Style - Modify Unit for Open Plan Application - \$95
- PREMIUM FINISH OPTION**
- MFB: Black metal finish - \$25 per foot
 - MFW: White metal finish - \$25 per foot
- SHELF**
- S25: Replace Black Laminate Shelf with Finished Shelf - \$75 per Shelf
- TRASH CAN**
- TRC50: EZ Cargo 50 dual trash can - (1) 8 gallon and (1) 5 gallon - \$650

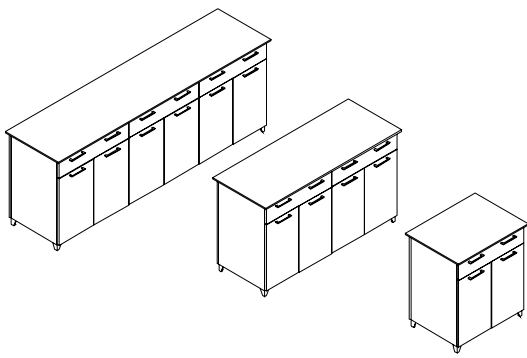

BUFFET / STORAGE CREDENZAS

STANDARD FEATURES

- 1 adjustable black laminate shelf behind each door set
- Soft close suspension drawer(s)
- Standard Silver Feet (optional White, Black)

NOTES

- Unit not designed for open plan use. Select OPB for Open Plan application

[CLICK HERE TO VIEW PRODUCT INDEX](#)

1 SELECT A STYLE

DIMENSIONS		STYLE NUMBER	LIST PRICE	STYLE NUMBER	LIST PRICE	STYLE NUMBER	LIST PRICE
"W" x D" x H"	WGT	"W" Veneer Veneer Top Veneer Chassis		"G" HPL High Pressure Laminate Top Veneer Chassis		"M" TFL Thermally Fused Laminate Top Thermally Fused Laminate Chassis	
95 x 24 x 36	400	NSS9524CA126W	4295	NSS9524CA126G	4295	NSS9524CA126M	3461
89 x 24 x 36	360	NSS8924CA126W	4160	NSS8924CA126G	4160	NSS8924CA126M	3242
72 x 24 x 36	300	NSS7224CA126W	3550	NSS7224CA126G	3550	NSS7224CA126M	2731
60 x 24 x 36	250	NSS6024CA126W	3370	NSS6024CA126G	3370	NSS6024CA126M	2642
37 x 24 x 36	150	NSS3724CA126W	1900	NSS3724CA126G	1900	NSS3724CA126M	1474
31 x 24 x 36	135	NSS3124CA126W	1770	NSS3124CA126G	1770	NSS3124CA126M	1433

2 SELECT A FINISH

"W" Veneer	"G" HPL	"M" TFL	
WAC	GAC	-	Amber Cherry
WRC	-	-	Caramel Cherry
WIC	GIC	-	Crimson Cherry
WEC	-	-	Ebony Cherry
WHC	GHC	MHC	Honey Cherry
WOC	GOC	MOC	KoKo Cherry
WSC	-	-	Scotch Cherry
WAM	GAM	-	Alabaster Maple
WCM	GCM	-	Clear Maple
WWM	GWM	-	Wheat Maple
WEW	GEW	-	Executive Walnut
WRW	GRW	-	Gray Luster Walnut
WGW	-	MGW	Gunstock Walnut
WJW	-	-	Judicial Walnut
WNW	GNW	-	Natural Walnut
WTW	GTW	MTW	Studio Teak Walnut
WWP	GWL	MWL	Designer White

METAL FINISHES

MFB	-	-	Black (Premium Finish)
MFS	-	-	Silver
MFW	-	-	White (Premium Finish)

3 SELECT AN EDGE

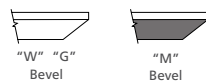

4 SELECT HARDWARE

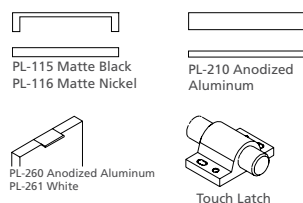

5 OPTIONS

- DOOR**
- D2: Door Lock - \$95 per Door Set
 - D6A: "W"/"G" Styles - Delete Doors and replace black laminate shelf with finished shelf - n/c
 - D9SC: Soft Close Door Hinges - \$15 per Door
- FEET**
- D8: Delete feet (includes extended fronts to the floor) - n/c
- FLUSH CUT**
- FC-B: Flush Unit Both Sides(Facing) for Ganging - \$50
 - FC-L: Flush Unit Left (Facing) for Ganging - \$50
 - FC-R: Flush Unit Right(Facing) for Ganging - \$50
- GROMMETS (STANDARD LOCATION)**
- Specify Color and Location (Right/Left/Center) - \$45 ea.
- Black: TM30-R (Right), TM30-L (Left), TM30-C (Center)
 - Silver: TM31-R (Right), TM31-L (Left), TM31-C (Center)
 - White: TM34-R (Right), TM34-L (Left), TM34-C (Center)
- GROMMETS (NON-STANDARD LOCATION)**
- Provide drawing w/ Grommet Location and Specify Color - \$90 ea.
- Black: TM30-NS
 - Silver: TM31-NS
 - White: TM34-NS
- GROMMET (VERTICAL SURFACE)**
- Standard Location - \$45 ea.
- Black Plastic Vertical Surface: TM50-C (Bottom Center)
 - Non-Standard Location - \$90 ea.
 - Black Plastic Vertical Surface: TM50-NS
- OPEN PLAN**
- OPB: "W" "G" Style - Modify Unit for Open Plan Application - \$195
 - OPBM: "M" Style - Modify Unit for Open Plan Application - \$95
- PREMIUM FINISH OPTION**
- MFB: Black metal finish - \$25 per foot
 - MFW: White metal finish - \$25 per foot
- TRASH CAN**
- TRC50: EZ Cargo 50 dual trash can - (1) 8 gallon and (1) 5 gallon - \$650

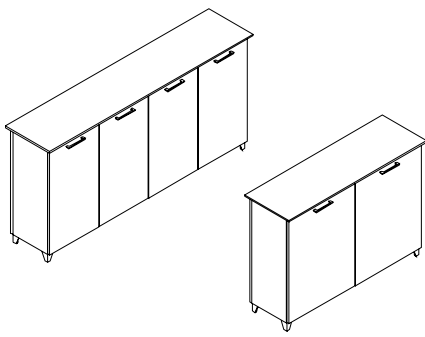

CONSOLE CABINETS

STANDARD FEATURES

- 1 adjustable black laminate shelf behind each section
- Interior shelf depth 12"
- Standard Silver Feet (optional White, Black)

NOTES

- Unit not designed for open plan use. Select OPB for Open Plan application

[CLICK HERE TO VIEW PRODUCT INDEX](#)

1 SELECT A STYLE

DIMENSIONS		STYLE NUMBER	LIST PRICE	STYLE NUMBER	LIST PRICE	STYLE NUMBER	LIST PRICE
W" x D" x H"	WGT	"W" Veneer Veneer Top Veneer Chassis		"G" HPL High Pressure Laminate Top Veneer Chassis		"M" TFL Thermally Fused Laminate Top Thermally Fused Laminate Chassis	
4 Door							
72 x 14 x 36	210	NSS7214CA524W	2945	NSS7214CA524G	2945	NSS7214CA524M	1898
60 x 14 x 36	175	NSS6014CA524W	2875	NSS6014CA524G	2875	NSS6014CA524M	1729
2 Door							
48 x 14 x 36	140	NSS4814CA524W	1770	NSS4814CA524G	1770	NSS4814CA524M	1240
36 x 14 x 36	110	NSS3614CA524W	1535	NSS3614CA524G	1535	NSS3614CA524M	1100

2 SELECT A FINISH

"W" Veneer	"G" HPL	"M" TFL	Finish
WAC	GAC	-	Amber Cherry
WRC	-	-	Caramel Cherry
WIC	GIC	-	Crimson Cherry
WEC	-	-	Ebony Cherry
WHC	GHC	MHC	Honey Cherry
WOC	GOC	MOC	KoKo Cherry
WSC	-	-	Scotch Cherry
WAM	GAM	-	Alabaster Maple
WCM	GCM	-	Clear Maple
WWM	GWM	-	Wheat Maple
WEW	GEW	-	Executive Walnut
WRW	GRW	-	Gray Luster Walnut
WGW	-	MGW	Gunstock Walnut
WJW	-	-	Judicial Walnut
WNW	GNW	-	Natural Walnut
WTW	GTW	MTW	Studio Teak Walnut
WWP	GWL	MWL	Designer White

METAL FINISHES

MFB	-	-	Black (Premium Finish)
MFS	-	-	Silver
MFW	-	-	White (Premium Finish)

3 SELECT AN EDGE

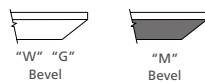

4 SELECT HARDWARE

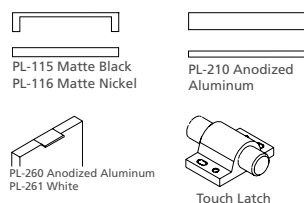

5 OPTIONS

- DOOR**
- D2: Door Lock - \$95 per Door Set
 - D6A: "W"/"G" Styles - Delete Doors and replace black laminate shelf with finished shelf - n/c
 - D95C: Soft Close Door Hinges - \$15 per Door
- FEET**
- D8: Delete feet (includes extended fronts to the floor) - n/c
- FLUSH CUT**
- FC-B: Flush Unit Both Sides(Facing) for Ganging - \$50
 - FC-L: Flush Unit Left (Facing) for Ganging - \$50
 - FC-R: Flush Unit Right(Facing) for Ganging - \$50
- GROMMETS (STANDARD LOCATION)**
- Specify Color and Location (Right/Left/Center) - \$45 ea.
- Black: TM30-R (Right), TM30-L (Left), TM30-C (Center)
 - Silver: TM31-R (Right), TM31-L (Left), TM31-C (Center)
 - White: TM34-R (Right), TM34-L (Left), TM34-C (Center)
 - TM50: Black grommet in back panel - \$45
- GROMMETS (NON-STANDARD LOCATION)**
- Provide drawing w/ Grommet Location and Specify Color - \$90 ea.
- Black: TM30-NS
 - Silver: TM31-NS
 - White: TM34-NS
- GROMMET (VERTICAL SURFACE)**
- Standard Location - \$45 ea.
- Black Plastic Vertical Surface: TM50-C (Bottom Center)
- Non-Standard Location - \$90 ea.
- Black Plastic Vertical Surface: TM50-NS
- OPEN PLAN**
- OPB: "W" "G" Style - Modify Unit for Open Plan Application - \$195
 - OPBM: "M" Style - Modify Unit for Open Plan Application - \$95
- SHELVES**
- S25: "W"/"G" Styles - Replace Black Laminate Shelf with Finished Shelf - \$75 per

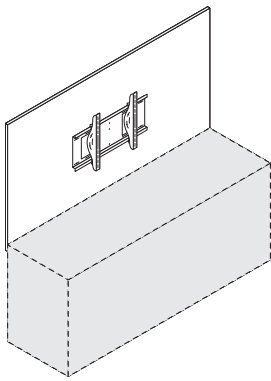

FLAT SCREEN WALL HUNG PANEL

STANDARD FEATURES

- 1.25" thick panel
- Back has (2) cable access cutouts
- Universal flat screen mount bracket

[CLICK HERE TO VIEW PRODUCT INDEX](#)

1 SELECT A STYLE

DIMENSIONS		STYLE NUMBER	LIST PRICE	STYLE NUMBER	LIST PRICE	STYLE NUMBER	LIST PRICE
W" x D" x H"	WGT	"W" Veneer Top Veneer Chassis		"G" HPL High Pressure Laminate Top Veneer Chassis		"M" TFL Thermally Fused Laminate Top Thermally Fused Laminate Chassis	
70 x 4 x 38	100	NSS7038WH575W	1219	"G" Option N/A		NSS7038WH575M	900
64 x 4 x 38	90	NSS6438WH575W	1169	"G" Option N/A		NSS6438WH575M	870
58 x 4 x 38	80	NSS5838WH575W	1166	"G" Option N/A		NSS5838WH575M	840
47 x 4 x 38	65	NSS4738WH575W	1095	"G" Option N/A		NSS4738WH575M	780
35 x 4 x 38	50	NSS3538WH575W	1042	"G" Option N/A		NSS3538WH575M	725

2 SELECT A FINISH **3 SELECT AN EDGE** **5 OPTIONS**

"W" Veneer	"G" HPL	"M" TFL	
WAC	-	-	Amber Cherry
WRC	-	-	Caramel Cherry
WIC	-	-	Crimson Cherry
WEC	-	-	Ebony Cherry
WHC	-	MHC	Honey Cherry
WOC	-	MOC	KoKo Cherry
WSC	-	-	Scotch Cherry
WAM	-	-	Alabaster Maple
WCM	-	-	Clear Maple
WWM	-	-	Wheat Maple
WEW	-	-	Executive Walnut
WRW	-	-	Gray Luster Walnut
WGW	-	MGW	Gunstock Walnut
WJW	-	-	Judicial Walnut
WNW	-	-	Natural Walnut
WTW	-	MTW	Studio Teak Walnut
WWP	-	MWL	Designer White

Edge Profile
Option Not Available

4 SELECT HARDWARE

Hardware
Option Not Available

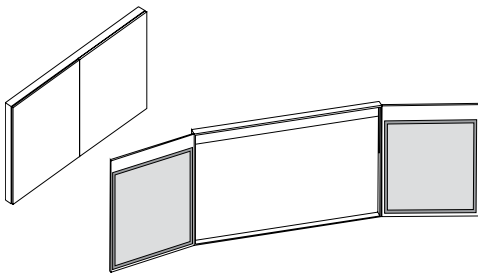

VISUAL BOARD

STANDARD FEATURES

- Built-in wall levelers
- Doors are 1" thick
- Fabric tack surface on doors (Spinel Sandstone)
- Finger pull at bottom
- White dry marker surface

[CLICK HERE TO VIEW PRODUCT INDEX](#)

1 SELECT A STYLE

DIMENSIONS		STYLE NUMBER	LIST PRICE	STYLE NUMBER	LIST PRICE	STYLE NUMBER	LIST PRICE
W" x D" x H"	WGT	"W" Veneer Top Veneer Chassis		"G" High Pressure Laminate Top Veneer Chassis		"M" Thermally Fused Laminate Top Thermally Fused Laminate Chassis	
48 x 4 x 48	130	NSS4848VB475W	2969	"G" Option N/A		NSS4848VB475M	1275
36 x 4 x 48	120	NSS3648VB475W	2718	"G" Option N/A		NSS3648VB475M	1230
48 x 4 x 36	120	NSS4836VB475W	2718	"G" Option N/A		NSS4836VB475M	1230
36 x 4 x 36	110	NSS3636VB475W	2093	"G" Option N/A		NSS3636VB475M	1185

2 SELECT A FINISH

"W" Veneer	"G" HPL	"M" TFL	Finish
WAC	-	-	Amber Cherry
WRC	-	-	Caramel Cherry
WIC	-	-	Crimson Cherry
WEC	-	-	Ebony Cherry
WHC	-	MHC	Honey Cherry
WOC	-	MOC	KoKo Cherry
WSC	-	-	Scotch Cherry
WAM	-	-	Alabaster Maple
WCM	-	-	Clear Maple
WWM	-	-	Wheat Maple
WEW	-	-	Executive Walnut
WRW	-	-	Gray Luster Walnut
WGW	-	MGW	Gunstock Walnut
WJW	-	-	Judicial Walnut
WNW	-	-	Natural Walnut
WTW	-	MTW	Studio Teak Walnut
WWP	-	MWL	Designer White

3 SELECT AN EDGE

Edge Profile
Option Not Available

4 SELECT HARDWARE

Hardware
Option Not Available

5 OPTIONS

- ACCESSORIES**
- DMKIT: Dry market kit for visual board - \$45
 - DMRT01: Replace fabric panels with dry marker/erase board - \$95
 - FC20: Flip Chart 34" x 20" - \$55 each

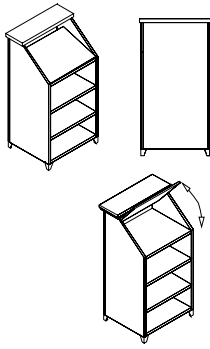

LECTERN

STANDARD FEATURES

- 2 Adjustable shelves
- Lectern surface tilts up for storage
- Standard Silver feet (optional White, Black)

[CLICK HERE TO VIEW PRODUCT INDEX](#)

1 SELECT A STYLE

DIMENSIONS		STYLE NUMBER	LIST PRICE	STYLE NUMBER	LIST PRICE	STYLE NUMBER	LIST PRICE
W" x D" x H"	WGT	"W" Veneer Top Veneer Chassis		"G" High Pressure Laminate Top HPL Veneer Chassis		"M" Thermally Fused Laminate Top TFL Thermally Fused Laminate Chassis	
24 x 24 x 46	130	NSS2424LC499W	2600	"G" Style N/A		NSS2424LC499M	1325

2 SELECT A FINISH

"W"	"G"	"M"	
Veneer	HPL	TFL	
WAC	-	-	Amber Cherry
WRC	-	-	Caramel Cherry
WIC	-	-	Crimson Cherry
WEC	-	-	Ebony Cherry
WHC	-	MHC	Honey Cherry
WOC	-	MOC	KoKo Cherry
WSC	-	-	Scotch Cherry
WAM	-	-	Alabaster Maple
WCM	-	-	Clear Maple
WWM	-	-	Wheat Maple
WEW	-	-	Executive Walnut
WRW	-	-	Gray Luster Walnut
WGW	-	MGW	Gunstock Walnut
WJW	-	-	Judicial Walnut
WNW	-	-	Natural Walnut
WTW	-	MTW	Studio Teak Walnut
WWP	-	MWL	Designer White

METAL FINISHES

MFB	-	-	Black (Premium Finish)
MFS	-	-	Silver
MFW	-	-	White (Premium Finish)

3 SELECT AN EDGE

Edge Profile
Option Not Available

4 SELECT HARDWARE

Hardware
Option Not Available

5 OPTIONS

- GROMMETS (NON-STANDARD LOCATION)**
Provide drawing w/ Grommet Location and Specify Color - \$90
- Black: TM30-NS
 - Silver: TM31-NS
 - Antique Brass: TM33-NS
- PREMIUM FINISH OPTION**
- MFB: Black metal finish - \$25 per foot
 - MFW: White metal finish - \$25 per foot

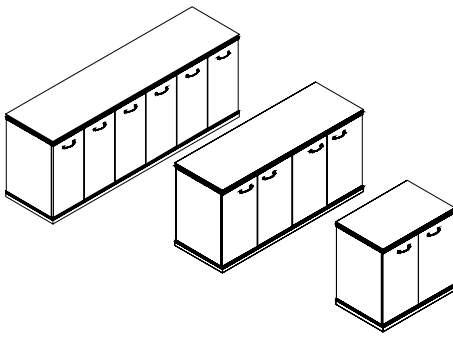

CONFERRING STORAGE CREDENZA

STANDARD FEATURES

- Adjustable glides
- Adjustable wood shelf per section
- Hardwood base / dentil molding

[CLICK HERE TO VIEW PRODUCT INDEX](#)

1 SELECT A STYLE

DIMENSIONS		STYLE NUMBER	LIST PRICE	STYLE NUMBER	LIST PRICE	STYLE NUMBER	LIST PRICE
W" x D" x H"	WGT	"W" Veneer Top Veneer Chassis		"G" HPL High Pressure Laminate Top Veneer Chassis		"M" TFL Thermally Fused Laminate Top Thermally Fused Laminate Chassis	
Triple Storage							
94 x 24 x 36	360	PRA9424CA124W	6450	PRA9424CA124G	6450	"M" Option N/A	
88 x 24 x 36	345	PRA8824CA124W	6327	PRA8824CA124G	6327	"M" Option N/A	
Double Storage							
71 x 24 x 36	270	PRA7124CA124W	4869	PRA7124CA124G	4869	"M" Option N/A	
65 x 24 x 36	260	PRA6524CA124W	4774	PRA6524CA124G	4774	"M" Option N/A	
59 x 24 x 36	220	PRA5924CA124W	4683	PRA5924CA124G	4683	"M" Option N/A	
48 x 24 x 36	210	PRA4824CA124W	4496	PRA4824CA124G	4496	"M" Option N/A	
Single Storage							
36 x 24 x 36	160	PRA3624CA124W	2785	PRA3624CA124G	2785	"M" Option N/A	
30 x 24 x 36	150	PRA3024CA124W	2663	PRA3024CA124G	2663	"M" Option N/A	

2 SELECT A FINISH

"W" Veneer	"G" HPL	"M" TFL	
WAC	GAC	-	Amber Cherry
WRC	-	-	Caramel Cherry
WIC	GIC	-	Crimson Cherry
WEC	-	-	Ebony Cherry
WHC	GHC	-	Honey Cherry
WOC	GOC	-	KoKo Cherry
WSC	-	-	Scotch Cherry
WEW	GEW	-	Executive Walnut
WRW	GRW	-	Gray Luster Walnut
WGW	-	-	Gunstock Walnut
WJW	-	-	Judicial Walnut
WNW	GNW	-	Natural Walnut
WTW	GTW	-	Studio Teak Walnut

3 SELECT AN EDGE



4 SELECT HARDWARE

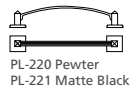
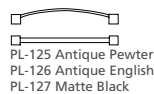
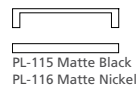

5 OPTIONS

- ACCESSORIES**
- REF-01: Modify Storage section for refrigerator - \$195
- AUDIO VISUAL**
- AVR1: AV Exhaust Fan - \$450
 - AVR2: AV Pullout Rack - \$1590
- BACK PANEL WALL ACCESS**
- M19: 2 Heat vent/cord access slots in back - \$ 150
- DOOR**
- D2: Wood Door Lock - \$95 per Door Set
- FLUSH CUT**
- FC-B: Flush Unit Both Sides(Facing) for Ganging - \$95
 - FC-L: Flush Unit Left (Facing) for Ganging - \$95
 - FC-R: Flush Unit Right(Facing) for Ganging - \$95
- OPEN PLAN**
- OPB: "W" "G" Style - Modify Unit for Open Plan Application - \$195
- TRASH CAN**
- TRC50: EZ Cargo 50 dual trash can - (1) 8 gallon and (1) 5 gallon - \$650

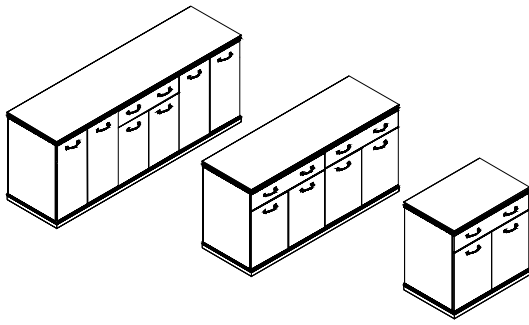

CONFERRING BUFFET CREDENZA

STANDARD FEATURES

- Adjustable wood shelf per section
- Utility drawer w/ felt liner

[CLICK HERE TO VIEW PRODUCT INDEX](#)

1 SELECT A STYLE

DIMENSIONS		STYLE NUMBER	LIST PRICE	STYLE NUMBER	LIST PRICE	STYLE NUMBER	LIST PRICE
W" x D" x H"	WGT	"W" Veneer Top Veneer Chassis		"G" HPL High Pressure Laminate Top Veneer Chassis		"M" TFL Thermally Fused Laminate Top Thermally Fused Laminate Chassis	
Triple Buffet							
94 x 24 x 36	350	PRA9424CA126W	6226	PRA9424CA126G	6226	"M" Option N/A	
Double Buffet							
71 x 24 x 36	300	PRA7124CA126W	5470	PRA7124CA126G	5470	"M" Option N/A	
Single Buffet							
36 x 24 x 36	160	PRA3624CA126W	2908	PRA3624CA126G	2908	"M" Option N/A	

2 SELECT A FINISH

"W" Veneer	"G" HPL	"M" TFL	
WAC	GAC	-	Amber Cherry
WRC	-	-	Caramel Cherry
WIC	GIC	-	Crimson Cherry
WEC	-	-	Ebony Cherry
WHC	GHC	-	Honey Cherry
WOC	GOC	-	KoKo Cherry
WSC	-	-	Scotch Cherry
WEW	GEW	-	Executive Walnut
WRW	GRW	-	Gray Luster Walnut
WGW	-	-	Gunstock Walnut
WJW	-	-	Judicial Walnut
WNW	GNW	-	Natural Walnut
WTW	GTW	-	Studio Teak Walnut

3 SELECT AN EDGE



5 OPTIONS

- ACCESSORIES**
- REF-01: Modify Storage section for refrigerator - \$195
- DOOR**
- D2: Wood Door Lock - \$95 per Door Set
- FLUSH CUT**
- FC-B: Flush Unit Both Sides(Facing) for Ganging - \$95
 - FC-L: Flush Unit Left (Facing) for Ganging - \$95
 - FC-R: Flush Unit Right(Facing) for Ganging - \$95
- OPEN PLAN**
- OPB: "W" "G" Style - Modify Unit for Open Plan Application - \$195
- TRASH CAN**
- TRC50: EZ Cargo 50 dual trash can - (1) 8 gallon and (1) 5 gallon - \$650

4 SELECT HARDWARE

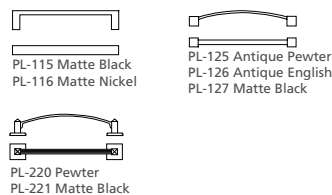

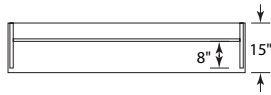
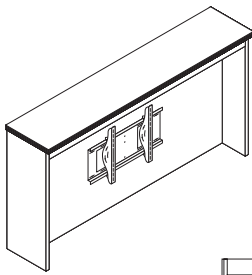

TRANSITIONAL FLAT SCREEN OVERHEAD SUPPORT

STANDARD FEATURES

- 1.25" thick panel
- Back has (2) cable access cutouts
- Top with Prado
- Universal flat screen mount bracket

[CLICK HERE TO VIEW PRODUCT INDEX](#)

1 SELECT A STYLE

DIMENSIONS		STYLE NUMBER	LIST PRICE	STYLE NUMBER	LIST PRICE	STYLE NUMBER	LIST PRICE
"W" x "D" x "H"	WGT	"W" Veneer Top Veneer Chassis		"G" HPL High Pressure Laminate Top Veneer Chassis		"M" TFL Thermally Fused Laminate Top Thermally Fused Laminate Chassis	
71 x 4 x 37	130	PRA7137OH573W	2219	"G" Option N/A		"M" Option N/A	
65 x 4 x 37	120	PRA6537OH573W	2159	"G" Option N/A		"M" Option N/A	
59 x 4 x 37	110	PRA5937OH573W	2093	"G" Option N/A		"M" Option N/A	
48 x 4 x 37	100	PRA4837OH573W	2035	"G" Option N/A		"M" Option N/A	
36 x 4 x 37	90	PRA3637OH573W	1939	"G" Option N/A		"M" Option N/A	

2 SELECT A FINISH

"W" Veneer	"G" HPL	"M" TFL	
WAC	-	-	Amber Cherry
WRC	-	-	Caramel Cherry
WIC	-	-	Crimson Cherry
WEC	-	-	Ebony Cherry
WHC	-	-	Honey Cherry
WOC	-	-	KoKo Cherry
WSC	-	-	Scotch Cherry
WEW	-	-	Executive Walnut
WRW	-	-	Gray Luster Walnut
WGW	-	-	Gunstock Walnut
WJW	-	-	Judicial Walnut
WNW	-	-	Natural Walnut
WTW	-	-	Studio Teak Walnut

3 SELECT AN EDGE



Prado

5 OPTIONS

FLUSH CUT

- FC-B: Flush Unit Both Sides(Facing) for Ganging - \$95
- FC-L: Flush Unit Left (Facing) for Ganging - \$95
- FC-R: Flush Unit Right(Facing) for Ganging - \$95

4 SELECT HARDWARE

Hardware Option Not Available

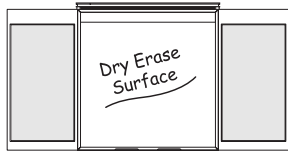
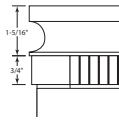
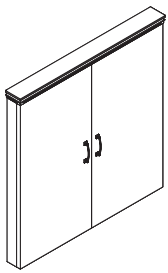

VISUAL BOARD

STANDARD FEATURES

- Built-in wall levelers
- Doors are 1" thick
- Fabric tack surface on doors (Spinel Sandstone)
- Finger pull at bottom
- White dry marker surface

[CLICK HERE TO VIEW PRODUCT INDEX](#)

1 SELECT A STYLE

DIMENSIONS		STYLE NUMBER	LIST PRICE	STYLE NUMBER	LIST PRICE	STYLE NUMBER	LIST PRICE
W" x D" x H"	WGT	"W" Veneer Top Veneer Chassis		"G" HPL High Pressure Laminate Top Veneer Chassis		"M" TFL Thermally Fused Laminate Top Thermally Fused Laminate Chassis	
48 x 4 x 48	130	PRA4848VB475W	2969	"G" Option N/A		"M" Option N/A	
36 x 4 x 48	120	PRA3648VB475W	2718	"G" Option N/A		"M" Option N/A	
48 x 4 x 36	120	PRA4836VB475W	2718	"G" Option N/A		"M" Option N/A	
36 x 4 x 36	110	PRA3636VB475W	2362	"G" Option N/A		"M" Option N/A	

2 SELECT A FINISH

"W" Veneer	"G" HPL	"M" TFL	
WAC	-	-	Amber Cherry
WRC	-	-	Caramel Cherry
WIC	-	-	Crimson Cherry
WEC	-	-	Ebony Cherry
WHC	-	-	Honey Cherry
WOC	-	-	KoKo Cherry
WSC	-	-	Scotch Cherry
WEW	-	-	Executive Walnut
WRW	-	-	Gray Luster Walnut
WGW	-	-	Gunstock Walnut
WJW	-	-	Judicial Walnut
WNW	-	-	Natural Walnut
WTW	-	-	Studio Teak Walnut

3 SELECT AN EDGE



5 OPTIONS

ACCESSORIES

- DMKIT: Dry market kit for visual board - \$45
- DMRT01: Replace fabric panels with dry marker/erase board - \$95
- FC20: Flip Chart 34" x 20" - \$55 each

4 SELECT HARDWARE

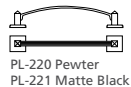
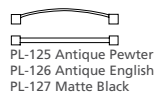

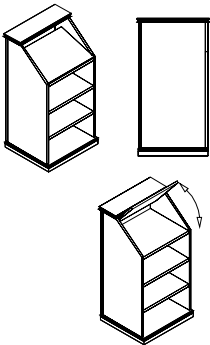

TRANSITIONAL LECTERN

STANDARD FEATURES

- 2 Adjustable shelves
- 2-1/2" Hardwood base
- Front wheels/casters for easy relocation
- Lectern surface tilts up for storage
- Molding (approach only)

[CLICK HERE TO VIEW PRODUCT INDEX](#)

1 SELECT A STYLE

DIMENSIONS		STYLE NUMBER	LIST PRICE	STYLE NUMBER	LIST PRICE	STYLE NUMBER	LIST PRICE
W" x D" x H"	WGT	"W" Veneer Top Veneer Chassis		"G" High Pressure Laminate Top HPL Veneer Chassis		"M" Thermally Fused Laminate Top TFL Thermally Fused Laminate Chassis	
24 x 24 x 46	130	PRA2424LC499W	3190	"G" Option N/A		"M" Option N/A	

2 SELECT A FINISH **3 SELECT AN EDGE** **5 OPTIONS**

"W" Veneer	"G" HPL	"M" TFL	
WAC	-	-	Amber Cherry
WRC	-	-	Caramel Cherry
WIC	-	-	Crimson Cherry
WEC	-	-	Ebony Cherry
WHC	-	-	Honey Cherry
WOC	-	-	KoKo Cherry
WSC	-	-	Scotch Cherry
WEW	-	-	Executive Walnut
WRW	-	-	Gray Luster Walnut
WGW	-	-	Gunstock Walnut
WJW	-	-	Judicial Walnut
WNW	-	-	Natural Walnut
WTW	-	-	Studio Teak Walnut

Edge Profile
Option Not Available

4 SELECT HARDWARE

Hardware
Option Not Available

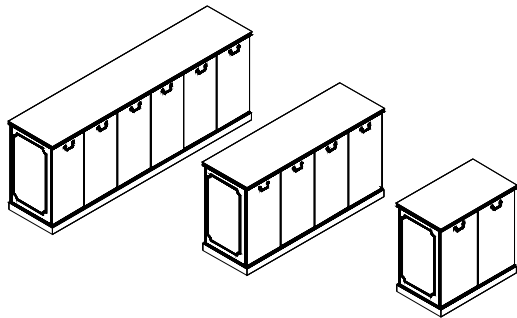

CONFERCING STORAGE CREDENZA

STANDARD FEATURES

- Adjustable black per section laminate shelf
- Adjustable glides
- Traditional - Molding, hardwood base & profile edge on drawers / doors

NOTES

- Ganging: For end to end ganging, specify ganging flush cut modification for each ganged unit

[CLICK HERE TO VIEW PRODUCT INDEX](#)

1 SELECT A STYLE

DIMENSIONS		STYLE NUMBER	LIST PRICE	STYLE NUMBER	LIST PRICE	STYLE NUMBER	LIST PRICE
W" x D" x H"	WGT	"W" Veneer Top Veneer Chassis		"G" High Pressure Laminate Top Veneer Chassis		"M" Thermally Fused Laminate Top Thermally Fused Laminate Chassis	
Triple Storage							
95 x 24 x 36	390	RPC9524CA124W	5710	RPC9524CA124G	5710	"M" Option N/A	
89 x 24 x 36	340	RPC8924CA124W	5578	RPC8924CA124G	5578	"M" Option N/A	
Double Storage							
72 x 24 x 36	290	RPC7224CA124W	4011	RPC7224CA124G	4011	"M" Option N/A	
66 x 24 x 36	260	RPC6624CA124W	3880	RPC6624CA124G	3880	"M" Option N/A	
60 x 24 x 36	245	RPC6024CA124W	3750	RPC6024CA124G	3750	"M" Option N/A	
48 x 24 x 36	200	RPC4824CA124W	3488	RPC4824CA124G	3488	"M" Option N/A	
Single Storage							
37 x 24 x 36	150	RPC3724CA124W	2314	RPC3724CA124G	2314	"M" Option N/A	
31 x 24 x 36	135	RPC3124CA124W	2183	RPC3124CA124G	2183	"M" Option N/A	

2 SELECT A FINISH

"W" Veneer	"G" HPL	"M" TFL	
WAC	GAC	-	Amber Cherry
WRC	-	-	Caramel Cherry
WIC	GIC	-	Crimson Cherry
WEC	-	-	Ebony Cherry
WHC	GHC	-	Honey Cherry
WOC	GOC	-	KoKo Cherry
WSC	-	-	Scotch Cherry
WEW	GEW	-	Executive Walnut
WRW	GRW	-	Gray Luster Walnut
WGW	-	-	Gunstock Walnut
WJW	-	-	Judicial Walnut
WNW	GNW	-	Natural Walnut
WTW	GTW	-	Studio Teak Walnut

3 SELECT AN EDGE



5 OPTIONS

- ACCESSORIES**
- REF-01: Modify Storage section for refrigerator - \$195
- AUDIO VISUAL**
- AVR1: AV Exhaust Fan - \$450
 - AVR2: AV Pullout Rack - \$1590
- BACK PANEL WALL ACCESS**
- M19: 2 Heat vent/cord access slots in back - \$ 150
- DOOR**
- D2: Wood Door Lock - \$95 per Door Set
 - D6A: "W"/"G" Styles - Delete Doors and replace black laminate shelf with finished shelf - n/c
- FLUSH CUT**
- FC-B: Flush Unit Both Sides(Facing) for Ganging - \$95
 - FC-L: Flush Unit Left (Facing) for Ganging - \$95
 - FC-R: Flush Unit Right(Facing) for Ganging - \$95
- OPEN PLAN**
- OPB: 'W "G" Style - Modify Unit for Open Plan Application - \$295
- TRASH CAN**
- TRC50: EZ Cargo 50 dual trash can - (1) 8 gallon and (1) 5 gallon - \$650

4 SELECT HARDWARE



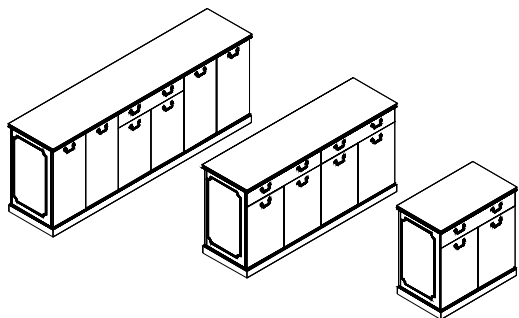

CONFERCING BUFFET CREDENZA

STANDARD FEATURES

- Adjustable glides
- Full extension drawers - locking
- Storage cabinet w/ adjustable black laminate shelf
- Traditional - Molding, hardwood base & profile edge on drawers / doors
- Utility drawer w/ felt liner

ganging flush cut modification for each ganged unit

NOTES

- Ganging: For end to end ganging, specify

[CLICK HERE TO VIEW PRODUCT INDEX](#)

1 SELECT A STYLE

DIMENSIONS		STYLE NUMBER	LIST PRICE	STYLE NUMBER	LIST PRICE	STYLE NUMBER	LIST PRICE
W" x D" x H"	WGT	"W" Veneer Top Veneer Chassis		"G" High Pressure Laminate Top Veneer Chassis		"M" Thermally Fused Laminate Top Thermally Fused Laminate Chassis	
Triple Buffet							
95 x 24 x 36	390	RPC9524CA126W	6232	RPC9524CA126G	6232	"M" Option N/A	
Double Buffet							
72 x 24 x 36	300	RPC7224CA126W	5187	RPC7224CA126G	5187	"M" Option N/A	
Single Buffet							
37 x 24 x 36	175	RPC3724CA126W	2905	RPC3724CA126G	2905	"M" Option N/A	

2 SELECT A FINISH

"W" Veneer	"G" HPL	"M" TFL	
WAC	GAC	-	Amber Cherry
WRC	-	-	Caramel Cherry
WIC	GIC	-	Crimson Cherry
WEC	-	-	Ebony Cherry
WHC	GHC	-	Honey Cherry
WOC	GOC	-	KoKo Cherry
WSC	-	-	Scotch Cherry
WEW	GEW	-	Executive Walnut
WRW	GRW	-	Gray Luster Walnut
WGW	-	-	Gunstock Walnut
WJW	-	-	Judicial Walnut
WNW	GNW	-	Natural Walnut
WTW	GTW	-	Studio Teak Walnut

3 SELECT AN EDGE



5 OPTIONS

- ACCESSORIES**
- REF-01: Modify Storage section for refrigerator - \$195
- AUDIO VISUAL**
- AVR1: AV Exhaust Fan - \$450
 - AVR2: AV Pullout Rack - \$1590
- BACK PANEL WALL ACCESS**
- M19: 2 Heat vent/cord access slots in back - \$ 150
- DOOR**
- D6A: "W"/"G" Styles - Delete Doors and replace black laminate shelf with finished shelf - n/c
- OPEN PLAN**
- OPB: "W" "G" Style - Modify Unit for Open Plan Application - \$295
- TRASH CAN**
- TRC50: EZ Cargo 50 dual trash can - (1) 8 gallon and (1) 5 gallon - \$650

4 SELECT HARDWARE



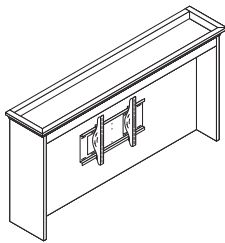

43"H Units Not For Ganging Flush Cut

FLAT SCREEN OVERHEAD SUPPORT

STANDARD FEATURES

- 1.25" thick panel
- Back has (2) cable access cutouts
- Universal flat screen mount bracket

NOTES

- Cornice adds 2.5"

[CLICK HERE TO VIEW PRODUCT INDEX](#)

1 SELECT A STYLE

DIMENSIONS		STYLE NUMBER	LIST PRICE	STYLE NUMBER	LIST PRICE	STYLE NUMBER	LIST PRICE
W" x D" x H"	WGT	"W" Veneer Top Veneer Chassis		"G" High Pressure Laminate Top Veneer Chassis		"M" Thermally Fused Laminate Top Thermally Fused Laminate Chassis	
70 x 15 x 36	130	RPC7036WH574W	2463	"G" Option N/A		"M" Option N/A	
64 x 15 x 36	120	RPC6436WH574W	2404	"G" Option N/A		"M" Option N/A	
58 x 15 x 36	110	RPC5836WH574W	2338	"G" Option N/A		"M" Option N/A	
47 x 15 x 36	100	RPC4736WH574W	2159	"G" Option N/A		"M" Option N/A	
35 x 15 x 36	90	RPC3536WH574W	2065	"G" Option N/A		"M" Option N/A	

2 SELECT A FINISH

"W" Veneer	"G" HPL	"M" TFL	Finish
WAC	-	-	Amber Cherry
WRC	-	-	Caramel Cherry
WIC	-	-	Crimson Cherry
WEC	-	-	Ebony Cherry
WHC	-	-	Honey Cherry
WOC	-	-	KoKo Cherry
WSC	-	-	Scotch Cherry
WEW	-	-	Executive Walnut
WRW	-	-	Gray Luster Walnut
WGW	-	-	Gunstock Walnut
WJW	-	-	Judicial Walnut
WNW	-	-	Natural Walnut
WTW	-	-	Studio Teak Walnut

3 SELECT AN EDGE

Edge Profile
Option Not Available

5 OPTIONS

- FLUSH CUT**
- FC-B: Flush Unit Both Sides(Facing) for Ganging - \$95
 - FC-L: Flush Unit Left (Facing) for Ganging - \$95
 - FC-R: Flush Unit Right(Facing) for Ganging - \$95

4 SELECT HARDWARE

Hardware
Option Not Available

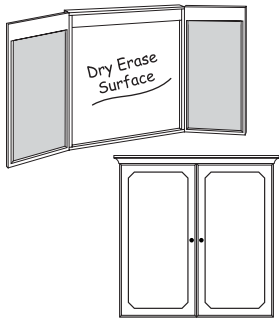

VISUAL BOARD

STANDARD FEATURES

- Built-in wall levelers
- Doors are 1" thick
- Fabric tack surface on doors (Spinel Sandstone)
- Finger pull at bottom
- White dry marker surface

[CLICK HERE TO VIEW PRODUCT INDEX](#)

1 SELECT A STYLE

DIMENSIONS		STYLE NUMBER	LIST PRICE	STYLE NUMBER	LIST PRICE	STYLE NUMBER	LIST PRICE
W" x D" x H"	WGT	"W" Veneer Top Veneer Chassis		"G" High Pressure Laminate Top HPL Veneer Chassis		"M" Thermally Fused Laminate Top Thermally Fused Laminate Chassis	
48 x 4 x 48	130	RPC4848VB475W	3403	"G" Option N/A		"M" Option N/A	
36 x 4 x 48	120	RPC3648VB475W	3153	"G" Option N/A		"M" Option N/A	
48 x 4 x 36	120	RPC4836VB475W	3153	"G" Option N/A		"M" Option N/A	
36 x 4 x 36	110	RPC3636VB475W	2528	"G" Option N/A		"M" Option N/A	

2 SELECT A FINISH

"W" Veneer	"G" HPL	"M" TFL	Finish
WAC	-	-	Amber Cherry
WRC	-	-	Caramel Cherry
WIC	-	-	Crimson Cherry
WEC	-	-	Ebony Cherry
WHC	-	-	Honey Cherry
WOC	-	-	KoKo Cherry
WSC	-	-	Scotch Cherry
WEW	-	-	Executive Walnut
WRW	-	-	Gray Luster Walnut
WGW	-	-	Gunstock Walnut
WJW	-	-	Judicial Walnut
WNW	-	-	Natural Walnut
WTW	-	-	Studio Teak Walnut

3 SELECT AN EDGE

Edge Profile
Option Not Available

5 OPTIONS

- ACCESSORIES**
- DMKIT: Dry market kit for visual board - \$45
 - DMRT01: Replace fabric panels with dry marker/erase board - \$95
 - FC20: Flip Chart 34" x 20" - \$55 each
- MOLDING**
- DSM2: Delete molding - Deduct \$50

4 SELECT HARDWARE



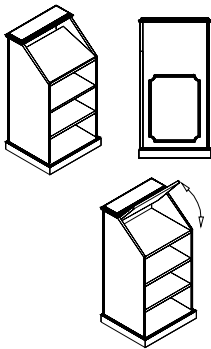

TRADITIONAL LECTERN

STANDARD FEATURES

- 2 Adjustable shelves
- 3-1/2" Hardwood base
- Front wheels/casters for easy relocation
- Lectern surface tilts up for storage
- Molding (approach only)

[CLICK HERE TO VIEW PRODUCT INDEX](#)

1 SELECT A STYLE

DIMENSIONS		STYLE NUMBER	LIST PRICE	STYLE NUMBER	LIST PRICE	STYLE NUMBER	LIST PRICE
W" x D" x H"	WGT	"W" Veneer Top Veneer Chassis		"G" HPL High Pressure Laminate Top Veneer Chassis		"M" TFL Thermally Fused Laminate Top Thermally Fused Laminate Chassis	
24 x 24 x 46	150	RPC2421LC499W	2750	"G" Option N/A		"M" Option N/A	

2 SELECT A FINISH **3 SELECT AN EDGE** **5 OPTIONS**

"W" Veneer	"G" HPL	"M" TFL	
WAC	-	-	Amber Cherry
WRC	-	-	Caramel Cherry
WIC	-	-	Crimson Cherry
WEC	-	-	Ebony Cherry
WHC	-	-	Honey Cherry
WOC	-	-	KoKo Cherry
WSC	-	-	Scotch Cherry
WEW	-	-	Executive Walnut
WRW	-	-	Gray Luster Walnut
WGW	-	-	Gunstock Walnut
WJW	-	-	Judicial Walnut
WNW	-	-	Natural Walnut
WTW	-	-	Studio Teak Walnut
WWP	-	-	Designer White

Edge Profile
Option Not Available

4 SELECT HARDWARE



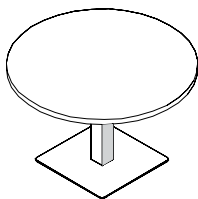

ROUND CONFERENCE TABLE WITH COLUMN

STANDARD FEATURES

- 1 -1/2" Thick work surface
- 4" x 4" Steel column with accent wood panel insert centered under top
- Flat edge standard
- Steel platform with self-leveling cushion bottom

[CLICK HERE TO VIEW PRODUCT INDEX](#)

1 SELECT A STYLE

DIMENSIONS		STYLE NUMBER	LIST PRICE	STYLE NUMBER	LIST PRICE	STYLE NUMBER	LIST PRICE
W" x D" x H"	WGT	"W" Veneer Veneer Top Veneer Chassis		"G" HPL High Pressure Laminate Top Veneer Chassis		"M" TFL Thermally Fused Laminate Top Thermally Fused Laminate Chassis	
48 DIA x 29.5	160	RFT4848DT089W	2550	"G" Option N/A		"M" Option N/A	
42 DIA x 29.5	150	RFT4242DT089W	2454	"G" Option N/A		"M" Option N/A	
36 DIA x 29.5	140	RFT3636DT089W	2376	"G" Option N/A		"M" Option N/A	
30 DIA x 29.5	135	RFT3030DT089W	2275	"G" Option N/A		"M" Option N/A	

2 SELECT A FINISH **3 SELECT AN EDGE** **5 OPTIONS**

"W" Veneer	"G" HPL	"M" TFL	
TBCO	-	-	Baby's Cheek +10%
TBSW	-	-	Brown Sugar
TFSO	-	-	Fifty Shades +10%
TFBO	-	-	Fun Blonde +10%
TFBW	-	-	French Bordeaux
TLLW	-	-	Luscious Lager
TOBW	-	-	Organic Brown
WWP	-	-	Designer White
TMMW	-	-	Mellow Mink



Flat 3 mm (Standard)

4 SELECT HARDWARE

Hardware
Option Not
Available

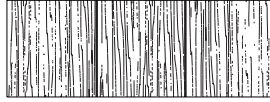
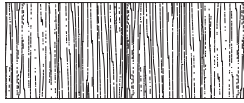

RECTANGLE

STANDARD FEATURES

- 1.5" thick
- Tops and bases are pre-located to ensure proper installation location

[CLICK HERE TO VIEW PRODUCT INDEX](#)

1 SELECT A STYLE

DIMENSIONS		STYLE NUMBER	LIST PRICE	STYLE NUMBER	LIST PRICE	STYLE NUMBER	LIST PRICE
W" x D" x H"	WGT	"W" Veneer Veneer Top Veneer Chassis		"G" HPL High Pressure Laminate Top Veneer Chassis		"M" TFL Thermally Fused Laminate Top Thermally Fused Laminate Chassis	
3 Piece Top							
240 x 60	545	RFT24060RE500W	9365	"G" Option N/A		"M" Option N/A	
240 x 54	530	RFT24054RE500W	8430	"G" Option N/A		"M" Option N/A	
216 x 60	475	RFT21660RE500W	8430	"G" Option N/A		"M" Option N/A	
216 x 54	455	RFT21654RE500W	7590	"G" Option N/A		"M" Option N/A	
2 Piece Top							
192 x 54	405	RFT19254RE500W	5775	"G" Option N/A		"M" Option N/A	
168 x 54	355	RFT16854RE500W	5620	"G" Option N/A		"M" Option N/A	
144 x 48	270	RFT14448RE500W	5135	"G" Option N/A		"M" Option N/A	
120 x 48	225	RFT12048RE500W	4845	"G" Option N/A		"M" Option N/A	
1 Piece Top							
96 x 48	190	RFT9648RE500W	2785	"G" Option N/A		"M" Option N/A	
84 x 42	145	RFT8442RE500W	2680	"G" Option N/A		"M" Option N/A	
72 x 36	110	RFT7236RE500W	2455	"G" Option N/A		"M" Option N/A	

2 SELECT A FINISH

"W" Veneer	"G" HPL	"M" TFL	
TBCO	-	-	Baby's Cheek +10%
TBSW	-	-	Brown Sugar
TFSO	-	-	Fifty Shades +10%
TFBO	-	-	Fun Blonde +10%
TFBW	-	-	French Bordeaux
TLLW	-	-	Luscious Lager
TMMW	-	-	Mellow Mink
TOBW	-	-	Organic Brown
WWP	-	-	Designer White

3 SELECT AN EDGE



5 OPTIONS

- OPTIONS**
- Power / data communications support module hardware available in options selection
 - Undertop wire trough and channels available in options section

4 SELECT HARDWARE

Hardware Option Not Available

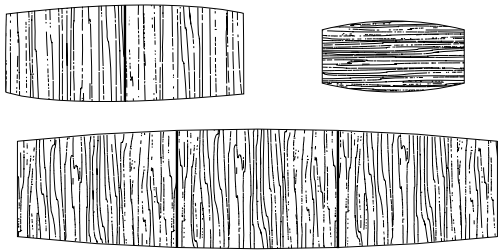

BOAT

STANDARD FEATURES

- 1.5" thick
- Tops and bases are pre-located to ensure proper installation location

[CLICK HERE TO VIEW PRODUCT INDEX](#)

1 SELECT A STYLE

DIMENSIONS		STYLE NUMBER	LIST PRICE	STYLE NUMBER	LIST PRICE	STYLE NUMBER	LIST PRICE
W" x D" x H"	WGT	"W" Veneer Top Veneer Veneer Chassis		"G" HPL High Pressure Laminate Top Veneer Chassis		"M" TFL Thermally Fused Laminate Top Thermally Fused Laminate Chassis	
3 Piece Top							
240 x 60	545	RFT24060BT500W	9833	"G" Option N/A		"M" Option N/A	
240 x 54	530	RFT24054BT500W	8852	"G" Option N/A		"M" Option N/A	
216 x 60	475	RFT21660BT500W	8852	"G" Option N/A		"M" Option N/A	
216 x 54	455	RFT21654BT500W	7970	"G" Option N/A		"M" Option N/A	
2 Piece Top							
192 x 54	385	RFT19254BT500W	6064	"G" Option N/A		"M" Option N/A	
168 x 54	335	RFT16854BT500W	5901	"G" Option N/A		"M" Option N/A	
144 x 48	250	RFT14448BT500W	5392	"G" Option N/A		"M" Option N/A	
120 x 48	215	RFT12048BT500W	5087	"G" Option N/A		"M" Option N/A	
1 Piece Top							
96 x 48	170	RFT9648BT500W	2924	"G" Option N/A		"M" Option N/A	
84 x 42	130	RFT8442BT500W	2814	"G" Option N/A		"M" Option N/A	
72 x 36	100	RFT7236BT500W	2578	"G" Option N/A		"M" Option N/A	

2 SELECT A FINISH

"W" Veneer	"G" HPL	"M" TFL	
TBCO	-	-	Baby's Cheek +10%
TBSW	-	-	Brown Sugar
TF50	-	-	Fifty Shades +10%
TFBO	-	-	Fun Blonde +10%
TFBW	-	-	French Bordeaux
TLLW	-	-	Luscious Lager
TMMW	-	-	Mellow Mink
TOBW	-	-	Organic Brown
WWP	-	-	Designer White

3 SELECT AN EDGE

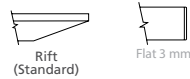

5 OPTIONS

- OPTIONS**
- Power / data communications support module hardware available in options selection
 - Undertop wire trough and channels available in options section

4 SELECT HARDWARE

Hardware Option Not Available

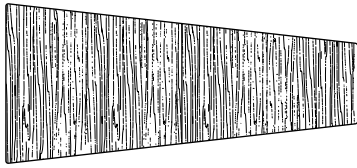
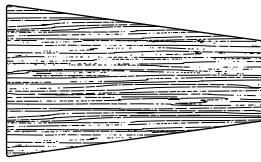

TELECOM WEDGE

STANDARD FEATURES

- 1.5" thick
- Tops and bases are pre-located to ensure proper installation location

NOTES

- Contact Customer Service for Base Suggestions

[CLICK HERE TO VIEW PRODUCT INDEX](#)

1 SELECT A STYLE

DIMENSIONS		STYLE NUMBER		LIST PRICE	STYLE NUMBER		LIST PRICE	STYLE NUMBER		LIST PRICE
W" x D" x H"	WGT	"W" Veneer	Veneer Top Veneer Chassis		"G" HPL	High Pressure Laminate Top Veneer Chassis		"M" TFL	Thermally Fused Laminate Top Thermally Fused Laminate Chassis	
2 Piece										
144 x 60/30	255	RFT14460WE500W		5392	"G" Option N/A			"M" Option N/A		
132 x 60/30	240	RFT13260WE500W		5240	"G" Option N/A			"M" Option N/A		
120 x 54/30	220	RFT12054WE500W		5087	"G" Option N/A			"M" Option N/A		
1 Piece Top										
96 x 51/30	175	RFT9651WE500W		2924	"G" Option N/A			"M" Option N/A		
84 x 48/30	135	RFT8448WE500W		2814	"G" Option N/A			"M" Option N/A		
72 x 42/28	105	RFT7242WE500W		2578	"G" Option N/A			"M" Option N/A		

2 SELECT A FINISH

"W" Veneer	"G" HPL	"M" TFL	
TBCO	-	-	Baby's Cheek +10%
TBSW	-	-	Brown Sugar
TFSO	-	-	Fifty Shades +10%
TFBO	-	-	Fun Blonde +10%
TFBW	-	-	French Bordeaux
TLLW	-	-	Luscious Lager
TMMW	-	-	Mellow Mink
TOBW	-	-	Organic Brown
WWP	-	-	Designer White

3 SELECT AN EDGE



5 OPTIONS

- OPTIONS**
- Power / data communications support module hardware available in options selection
 - Undertop wire trough and channels available in options section

4 SELECT HARDWARE

Hardware Option Not Available

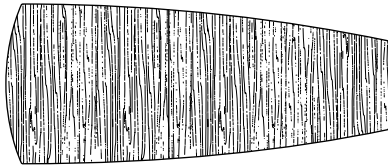
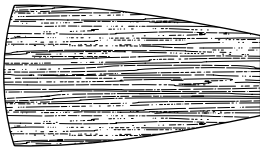

MIDSHIP

STANDARD FEATURES

- 1.5" thick
- Tops and bases are pre-located to ensure proper installation location

NOTES

- Contact Customer Service for Base Suggestions

[CLICK HERE TO VIEW PRODUCT INDEX](#)

1 SELECT A STYLE

DIMENSIONS		STYLE NUMBER	LIST PRICE	STYLE NUMBER	LIST PRICE	STYLE NUMBER	LIST PRICE
W" x D" x H"	WGT	"W" Veneer Top Veneer Chassis		"G" HPL High Pressure Laminate Top Veneer Chassis		"M" TFL Thermally Fused Laminate Top Thermally Fused Laminate Chassis	
2 Piece							
144 x 60/30	255	RFT14460MD500W	5392	"G" Option N/A		"M" Option N/A	
132 x 60/30	240	RFT13260MD500W	5240	"G" Option N/A		"M" Option N/A	
120 x 54/30	220	RFT12054MD500W	5087	"G" Option N/A		"M" Option N/A	
1 Piece Top							
96 x 51/30	175	RFT9651MD500W	2924	"G" Option N/A		"M" Option N/A	
84 x 48/30	135	RFT8448MD500W	2814	"G" Option N/A		"M" Option N/A	
72 x 42/28	105	RFT7242MD500W	2578	"G" Option N/A		"M" Option N/A	

2 SELECT A FINISH

"W" Veneer	"G" HPL	"M" TFL	
TBCO	-	-	Baby's Cheek +10%
TBSW	-	-	Brown Sugar
TF50	-	-	Fifty Shades +10%
TFBO	-	-	Fun Blonde +10%
TFBW	-	-	French Bordeaux
TLLW	-	-	Luscious Lager
TMMW	-	-	Mellow Mink
TOBW	-	-	Organic Brown
WWP	-	-	Designer White

3 SELECT AN EDGE



5 OPTIONS

- OPTIONS**
- Power / data communications support module hardware available in options selection
 - Undertop wire trough and channels available in options section

4 SELECT HARDWARE

Hardware Option Not Available

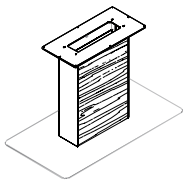

STATIONARY BASE

STANDARD FEATURES

- Steel column base with accent wood panel insert
- Steel platform base with self-leveling cushion bottom
- Wood panel sides attach with magnet and are easily removable for wire access

ordered

NOTES

- Power units can not be specified over base.
- Wire trough is required if power units are

[CLICK HERE TO VIEW PRODUCT INDEX](#)

1 SELECT A STYLE

DIMENSIONS		STYLE NUMBER	LIST PRICE	STYLE NUMBER	LIST PRICE	STYLE NUMBER	LIST PRICE
W" x D" x H"	WGT	"W" Veneer Top Veneer Chassis		"G" HPL High Pressure Laminate Top Veneer Chassis		"M" TFL Thermally Fused Laminate Top Thermally Fused Laminate Chassis	
42 x 22	110	RFB4222MB986	2125	"G" Option N/A		"M" Option N/A	
25 x 12	100	RFB2512MB986	1625	"G" Option N/A		"M" Option N/A	

2 SELECT A FINISH **3 SELECT AN EDGE** **5 OPTIONS**

"W" Veneer	"G" HPL	"M" TFL	
TBCO	-	-	Baby's Cheek +10%
TBSW	-	-	Brown Sugar
TFSO	-	-	Fifty Shades +10%
TFBO	-	-	Fun Blonde +10%
TFBW	-	-	French Bordeaux
TLLW	-	-	Luscious Lager
TMMW	-	-	Mellow Mink
TOBW	-	-	Organic Brown
WWP	-	-	Designer White

4 SELECT HARDWARE

Hardware
Option Not
Available

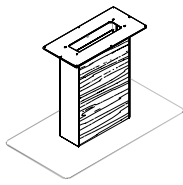

ADJUSTABLE HEIGHT BASE

STANDARD FEATURES

- Electronic mechanism with programmable lift
- Steel column base with accent wood panel insert
- Steel platform base with self-leveling cushion bottom
- Wood panel sides attach with magnet and are easily removable for wire access

Wire trough is required if power units are ordered

NOTES

- Power units can not be specified over base.

[CLICK HERE TO VIEW PRODUCT INDEX](#)

1 SELECT A STYLE

DIMENSIONS		STYLE NUMBER	LIST PRICE	STYLE NUMBER	LIST PRICE	STYLE NUMBER	LIST PRICE
W" x D" x H"	WGT	"W" Veneer Veneer Top Veneer Chassis		"G" HPL High Pressure Laminate Top Veneer Chassis		"M" TFL Thermally Fused Laminate Top Thermally Fused Laminate Chassis	
42 x 22	110	RFB4222MB987	4145	"G" Option N/A		"M" Option N/A	
25 x 12	100	RFB2512MB987	3645	"G" Option N/A		"M" Option N/A	

2 SELECT A FINISH

"W" Veneer	"G" HPL	"M" TFL	
TBCO	-	-	Baby's Cheek +10%
TBSW	-	-	Brown Sugar
TFSO	-	-	Fifty Shades +10%
TFBO	-	-	Fun Blonde +10%
TFBW	-	-	French Bordeaux
TLLW	-	-	Luscious Lager
TMMW	-	-	Mellow Mink
TOBW	-	-	Organic Brown
WWP	-	-	Designer White

3 SELECT AN EDGE

5 OPTIONS

- BASES**
- Linking Cable
 - LINK2: Linking cable: Linkage for two base tables - \$175
 - LINK3: Linking cable: Linkage for three base tables - \$300

4 SELECT HARDWARE

Hardware Option Not Available

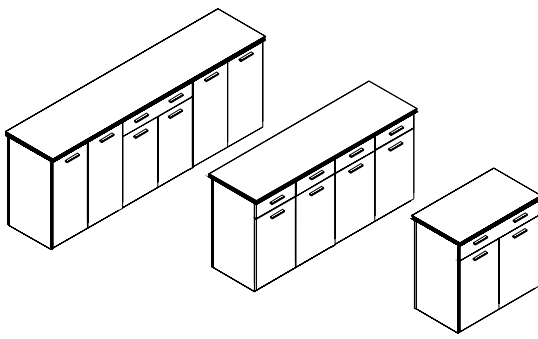

BUFFET CREDENZA

STANDARD FEATURES

- Floor levelers
- Storage cabinet w/ adjustable wood shelf
- Utility drawer w/ felt liner

NOTES

- Product can not be modified to 24" depth

[CLICK HERE TO VIEW PRODUCT INDEX](#)

1 SELECT A STYLE

DIMENSIONS		STYLE NUMBER	LIST PRICE	STYLE NUMBER	LIST PRICE	STYLE NUMBER	LIST PRICE
W" x D" x H"	WGT	"W" Veneer Veneer Top Veneer Chassis		"G" HPL High Pressure Laminate Top Veneer Chassis		"M" TFL Thermally Fused Laminate Top Thermally Fused Laminate Chassis	
Triple Buffet							
96 x 22 x 36	490	RFT9622CA126W	6380	"G" Option N/A		"M" Option N/A	
Double Buffet							
72 x 22 x 36	340	RFT7222CA126W	4995	"G" Option N/A		"M" Option N/A	
Single Buffet							
36 x 22 x 36	170	RFT3622CA126W	2545	"G" Option N/A		"M" Option N/A	

2 SELECT A FINISH

"W" Veneer	"G" HPL	"M" TFL	
TBCO	-	-	Baby's Cheek +10%
TBSW	-	-	Brown Sugar
TFSO	-	-	Fifty Shades +10%
TFBO	-	-	Fun Blonde +10%
TFBW	-	-	French Bordeaux
TLLW	-	-	Luscious Lager
TMMW	-	-	Mellow Mink
TOBW	-	-	Organic Brown
WWP	-	-	Designer White

3 SELECT AN EDGE



5 OPTIONS

ACCESSORIES

- REF-01: Modify Storage section for refrigerator - \$195

DOOR

- D2: Wood Door Lock - \$95 per Door Set
- D2: Wood Drawer Lock - \$95 per drawer Set

OPEN PLAN

- OPB: "W" "G" Style - Modify Unit for Open Plan Application - \$195

TOP

- Clear Top
- CCG-36: clear glass on metal standoffs for 36 degree credenza--\$695 list.
- CCG-72: clear glass on metal standoffs for 72 degree credenza--\$1,175 list.
- CCG-96: clear glass on metal standoffs for 96 degree credenza--\$1,585 list.
- Frosted Top
- CFG-36: frosted glass on metal standoffs for 36 degree credenza--\$865 list.
- CFG-72: frosted glass on metal standoffs for 72 degree credenza--\$1,525 list.
- CFG-96: frosted glass on metal standoffs for 96 degree credenza--\$2,030 list.

TRASH CAN

- TRC50: EZ Cargo 50 dual trash can - (1) 8 gallon and (1) 5 gallon - \$650

4 SELECT HARDWARE

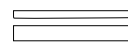

FOR BOX OR FILE: PL-300 Matte Chrome
FOR LATERALS: PL-301 Matte Chrome

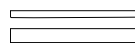

FOR BOX OR FILE: PL-302 White
FOR LATERALS: PL-303 White



FOR BOX OR FILE: PL-304 Matte Chrome
FOR LATERALS: PL-305 Matte Chrome

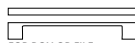

FOR BOX OR FILE: PL-305 White
FOR LATERALS: PL-307 White

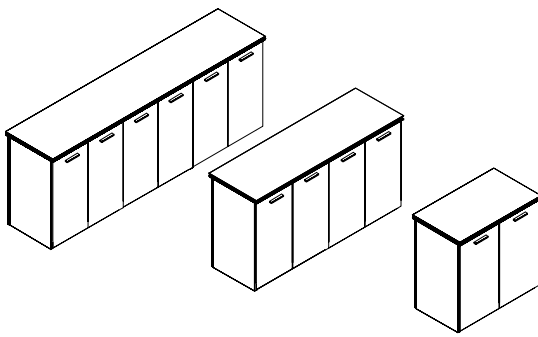

STORAGE CREDENZA

STANDARD FEATURES

- Adjustable black shelf per door section
- Floor levelers

NOTES

- Product can not be modified to 24" depth

[CLICK HERE TO VIEW PRODUCT INDEX](#)

1 SELECT A STYLE

DIMENSIONS		STYLE NUMBER	LIST PRICE	STYLE NUMBER	LIST PRICE	STYLE NUMBER	LIST PRICE
W" x D" x H"	WGT	"W" Veneer Top Veneer Chassis		"G" HPL High Pressure Laminate Top Veneer Chassis		"M" TFL Thermally Fused Laminate Top Thermally Fused Laminate Chassis	
Triple Storage							
96 x 22 x 36	480	RFT9622CA124W	6265	"G" Option N/A		"M" Option N/A	
Double Storage							
72 x 22 x 36	330	RFT7222CA124W	4695	"G" Option N/A		"M" Option N/A	
Single Storage							
36 x 22 x 36	165	RFT3622CA124W	2395	"G" Option N/A		"M" Option N/A	

2 SELECT A FINISH

"W" Veneer	"G" HPL	"M" TFL	
TBCO	-	-	Baby's Cheek +10%
TBSW	-	-	Brown Sugar
TFSO	-	-	Fifty Shades +10%
TFBO	-	-	Fun Blonde +10%
TFBW	-	-	French Bordeaux
TLLW	-	-	Luscious Lager
TMMW	-	-	Mellow Mink
TOBW	-	-	Organic Brown
WWP	-	-	Designer White

3 SELECT AN EDGE



Flat 3 mm

5 OPTIONS

- ACCESSORIES**
- REF-01: Modify Storage section for refrigerator - \$195
- DOOR**
- D2: Wood Door Lock - \$95 per Door Set
- OPEN PLAN**
- OPB: "W" "G" Style - Modify Unit for Open Plan Application - \$195
- TOP**
- Clear Top
- CCG-36: clear glass on metal standoffs for 36 degree credenza--\$695 list.
 - CCG-72: clear glass on metal standoffs for 72 degree credenza--\$1,175 list.
 - CCG-96: clear glass on metal standoffs for 96 degree credenza--\$1,585 list.
- Frosted Top
- CFG-36: frosted glass on metal standoffs for 36 degree credenza--\$865 list.
 - CFG-72: frosted glass on metal standoffs for 72 degree credenza--\$1,525 list.
 - CFG-96: frosted glass on metal standoffs for 96 degree credenza--\$2,030 list.

4 SELECT HARDWARE

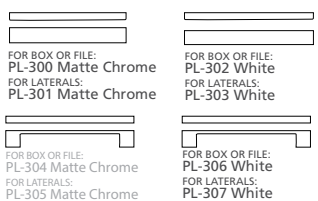

FOR BOX OR FILE: PL-300 Matte Chrome
FOR LATERALS: PL-301 Matte Chrome

FOR BOX OR FILE: PL-302 White
FOR LATERALS: PL-303 White

FOR BOX OR FILE: PL-304 Matte Chrome
FOR LATERALS: PL-305 Matte Chrome

FOR BOX OR FILE: PL-306 White
FOR LATERALS: PL-307 White

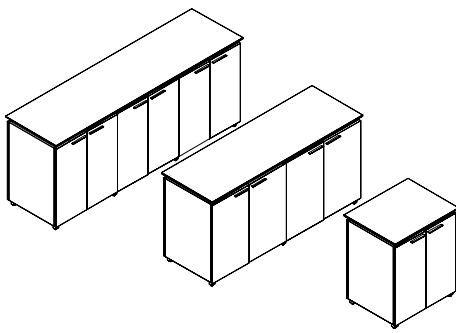

CONFERENCE STORAGE CREDENZA

STANDARD FEATURES

- Adjustable glides
- Metal feet and bases standard silver
- Wood adjustable shelf std per door section

NOTES

- When using with towers and overheads, choose flush cut

[CLICK HERE TO VIEW PRODUCT INDEX](#)

1 SELECT A STYLE

DIMENSIONS		STYLE NUMBER	LIST PRICE	STYLE NUMBER	LIST PRICE	STYLE NUMBER	LIST PRICE
W" x D" x H"	WGT	"W" Veneer Veneer Top Veneer Chassis		"G" HPL High Pressure Laminate Top Veneer Chassis		"M" TFL Thermally Fused Laminate Top Thermally Fused Laminate Chassis	
Triple Storage							
94 x 24 x 36	330	SPC9424CA124W	5748	SPC9424CA124G	5748	"M" Option N/A	
88 x 24 x 36	310	SPC8824CA124W	5667	SPC8824CA124G	5667	"M" Option N/A	
Double Storage							
71 x 24 x 36	260	SPC7124CA124W	4377	SPC7124CA124G	4377	"M" Option N/A	
65 x 24 x 36	250	SPC6524CA124W	4280	SPC6524CA124G	4280	"M" Option N/A	
59 x 24 x 36	230	SPC5924CA124W	4180	SPC5924CA124G	4180	"M" Option N/A	
48 x 24 x 36	210	SPC4824CA124W	4095	SPC4824CA124G	4095	"M" Option N/A	
Single Storage							
36 x 24 x 36	130	SPC3624CA124W	2230	SPC3624CA124G	2230	"M" Option N/A	
30 x 24 x 36	115	SPC3024CA124W	2174	SPC3024CA124G	2174	"M" Option N/A	

2 SELECT A FINISH

"W" Veneer	"G" HPL	"M" TFL	Finish
WAC	GAC	-	Amber Cherry
WRC	-	-	Caramel Cherry
WIC	GIC	-	Crimson Cherry
WEC	-	-	Ebony Cherry
WHC	GHC	-	Honey Cherry
WOC	GOC	-	KoKo Cherry
WSC	-	-	Scotch Cherry
WAM	GAM	-	Alabaster Maple
WCM	GCM	-	Clear Maple
WWM	GWM	-	Wheat Maple
WBO	-	-	Blush Oak
WMO	-	-	Mocha Oak
WTO	-	-	Toast Oak
WWO	-	-	Wheat Oak
WEW	GEW	-	Executive Walnut
WRW	GRW	-	Gray Luster Walnut
GWG	-	-	Gunstock Walnut
WJW	-	-	Judicial Walnut
WNW	GNW	-	Natural Walnut
WTW	GTW	-	Studio Teak Walnut
WWP	GWL	-	Designer White
METAL FINISHES			
MFS	-	-	Silver

3 SELECT AN EDGE



Bevel

4 SELECT HARDWARE

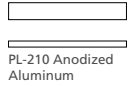

PL-210 Anodized Aluminum



PL-250 Aluminum

5 OPTIONS

- ACCESSORIES**
- REF-01: Modify Storage section for refrigerator - \$195
- AUDIO VISUAL**
- AVR1: AV Exhaust Fan - \$450
 - AVR2: AV Pullout Rack - \$1590
- BACK PANEL WALL ACCESS**
- M19: 2 Heat vent/cord access slots in back - \$ 150
- FEET**
- D8: Delete Feet (extended fronts to the floor) - n/c
- FLUSH CUT**
- FC-B: Flush Unit Both Sides(Facing) for Ganging - n/c
 - FC-L: Flush Unit Left (Facing) for Ganging - n/c
 - FC-R: Flush Unit Right(Facing) for Ganging - n/c
- OPEN PLAN**
- OPB: "W" "G" Style - Modify Unit for Open Plan Application - \$195
- TRASH CAN**
- TRC50: EZ Cargo 50 dual trash can - (1) 8 gallon and (1) 5 gallon - \$650

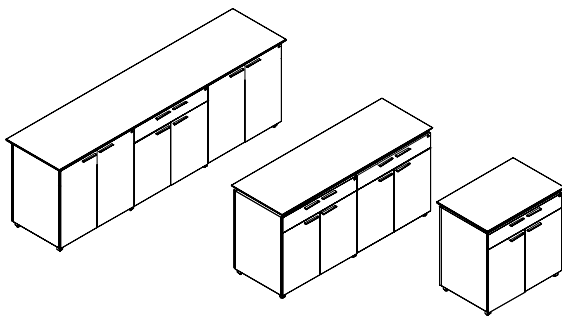

CONFERRING BUFFET CREDENZA

STANDARD FEATURES

- Adjustable glides
- Adjustable glides
- Full extension drawers - locking drawer
- Metal feet and bases standard silver
- "M" styles shelves match finish
- "W"/"G" styles have black adjustable shelf
- Utility drawer w/ felt liner
- Soft close suspension drawer(s)

- When using with towers and overheads, choose optional flush cut

NOTES

[CLICK HERE TO VIEW PRODUCT INDEX](#)

1 SELECT A STYLE

DIMENSIONS		STYLE NUMBER	LIST PRICE	STYLE NUMBER	LIST PRICE	STYLE NUMBER	LIST PRICE
W" x D" x H"	WGT	"W" Veneer Veneer Top Veneer Chassis		"G" HPL High Pressure Laminate Top Veneer Chassis		"M" TFL Thermally Fused Laminate Top Thermally Fused Laminate Chassis	
Triple Buffet							
94 x 24 x 36	350	SPC9424CA126W	5846	SPC9424CA126G	5846	"M" Option N/A	
Double Buffet							
71 x 24 x 36	250	SPC7124CA126W	4491	SPC7124CA126G	4491	"M" Option N/A	
Single Buffet							
36 x 24 x 36	120	SPC3624CA126W	2466	SPC3624CA126G	2466	"M" Option N/A	

2 SELECT A FINISH

"W" Veneer	"G" HPL	"M" TFL	
WAC	GAC	-	Amber Cherry
WRC	-	-	Caramel Cherry
WIC	GIC	-	Crimson Cherry
WEC	-	-	Ebony Cherry
WHC	GHC	-	Honey Cherry
WOC	GOC	-	KoKo Cherry
WSC	-	-	Scotch Cherry
WAM	GAM	-	Alabaster Maple
WCM	GCM	-	Clear Maple
WWM	GWM	-	Wheat Maple
WBO	-	-	Blush Oak
WMO	-	-	Mocha Oak
WTO	-	-	Toast Oak
WWO	-	-	Wheat Oak
WEW	GEW	-	Executive Walnut
WRW	GRW	-	Gray Luster Walnut
WGW	-	-	Gunstock Walnut
WJW	-	-	Judicial Walnut
WNW	GNW	-	Natural Walnut
WTW	GTW	-	Studio Teak Walnut
WWP	GWL	-	Designer White

3 SELECT AN EDGE



Bevel

4 SELECT HARDWARE

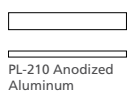

PL-210 Anodized Aluminum



PL-250 Aluminum

5 OPTIONS

- ACCESSORIES**
- REF-01: Modify Storage section for refrigerator - \$195
- BACK PANEL WALL ACCESS**
- M19: 2 Heat vent/cord access slots in back - \$ 150
- FEET**
- D8: Delete Feet (extended fronts to the floor) - n/c
- FLUSH CUT**
- FC-B: Flush Unit Both Sides(Facing) for Ganging - n/c
 - FC-L: Flush Unit Left (Facing) for Ganging - n/c
 - FC-R: Flush Unit Right(Facing) for Ganging - n/c
- OPEN PLAN**
- OPB: "W" "G" Style - Modify Unit for Open Plan Application - \$195
- TRASH CAN**
- TRC50: EZ Cargo 50 dual trash can - (1) 8 gallon and (1) 5 gallon - \$650

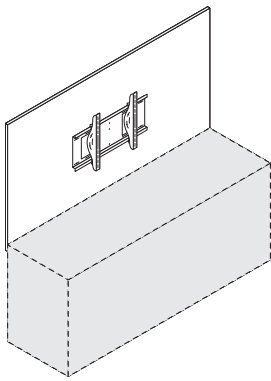

FLAT SCREEN WALL HUNG PANEL

STANDARD FEATURES

- 1.25" thick panel
- Back has (2) cable access cutouts
- Universal flat screen mount bracket

[CLICK HERE TO VIEW PRODUCT INDEX](#)

1 SELECT A STYLE

DIMENSIONS		STYLE NUMBER	LIST PRICE	STYLE NUMBER	LIST PRICE	STYLE NUMBER	LIST PRICE
W" x D" x H"	WGT	"W" Veneer Top Veneer Chassis		"G" HPL High Pressure Laminate Top Veneer Chassis		"M" TFL Thermally Fused Laminate Top Thermally Fused Laminate Chassis	
70 x 4 x 38	100	SPC7038WH575W	1219	"G" Option N/A		"M" Option N/A	
64 x 4 x 38	90	SPC6438WH575W	1196	"G" Option N/A		"M" Option N/A	
58 x 4 x 38	80	SPC5838WH575W	1166	"G" Option N/A		"M" Option N/A	
47 x 4 x 38	65	SPC4738WH575W	1095	"G" Option N/A		"M" Option N/A	
35 x 4 x 38	50	SPC3538WH575W	1042	"G" Option N/A		"M" Option N/A	

2 SELECT A FINISH **3 SELECT AN EDGE** **5 OPTIONS**

"W" Veneer	"G" HPL	"M" TFL	
WAC	-	-	Amber Cherry
WRC	-	-	Caramel Cherry
WIC	-	-	Crimson Cherry
WEC	-	-	Ebony Cherry
WHC	-	-	Honey Cherry
WOC	-	-	KoKo Cherry
WSC	-	-	Scotch Cherry
WAM	-	-	Alabaster Maple
WCM	-	-	Clear Maple
WWM	-	-	Wheat Maple
WBO	-	-	Blush Oak
WMO	-	-	Mocha Oak
WTO	-	-	Toast Oak
WWO	-	-	Wheat Oak
WEW	-	-	Executive Walnut
WRW	-	-	Gray Luster Walnut
GW	-	-	Gunstock Walnut
WJW	-	-	Judicial Walnut
WNW	-	-	Natural Walnut
WTW	-	-	Studio Teak Walnut
WWP	-	-	Designer White

Edge Profile
Option Not Available

4 SELECT HARDWARE

Hardware
Option Not Available

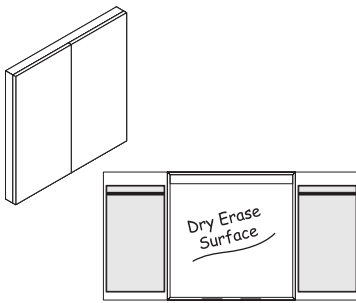

VISUAL BOARD

STANDARD FEATURES

- Built-in wall levelers
- Doors are 1" thick
- Fabric tack surface on doors (Spinel Sandstone)
- Finger pulls
- White dry marker surface

[CLICK HERE TO VIEW PRODUCT INDEX](#)

1 SELECT A STYLE

DIMENSIONS		STYLE NUMBER	LIST PRICE	STYLE NUMBER	LIST PRICE	STYLE NUMBER	LIST PRICE
W" x D" x H"	WGT	"W" Veneer Top Veneer Chassis		"G" High Pressure Laminate Top HPL Veneer Chassis		"M" Thermally Fused Laminate Top Thermally Fused Laminate Chassis	
48 x 4 x 48	130	SPC4848VB475W	3403	"G" Option N/A		"M" Option N/A	
36 x 4 x 48	120	SPC3648VB475W	3153	"G" Option N/A		"M" Option N/A	
48 x 4 x 36	120	SPC4836VB475W	3153	"G" Option N/A		"M" Option N/A	
36 x 4 x 36	110	SPC3636VB475W	2528	"G" Option N/A		"M" Option N/A	

2 SELECT A FINISH

"W" Veneer	"G" HPL	"M" TFL	Finish
WAC	-	-	Amber Cherry
WRC	-	-	Caramel Cherry
WIC	-	-	Crimson Cherry
WEC	-	-	Ebony Cherry
WHC	-	-	Honey Cherry
WOC	-	-	KoKo Cherry
WSC	-	-	Scotch Cherry
WAM	-	-	Alabaster Maple
WCM	-	-	Clear Maple
WWM	-	-	Wheat Maple
WBO	-	-	Blush Oak
WMO	-	-	Mocha Oak
WTO	-	-	Toast Oak
WWO	-	-	Wheat Oak
WEW	-	-	Executive Walnut
WRW	-	-	Gray Luster Walnut
GW	-	-	Gunstock Walnut
WJW	-	-	Judicial Walnut
WNW	-	-	Natural Walnut
WTW	-	-	Studio Teak Walnut
WWP	-	-	Designer White

3 SELECT AN EDGE

Edge Profile
Option Not Available

4 SELECT HARDWARE

Hardware
Option Not Available

5 OPTIONS

ACCESSORIES

- DMKIT: Dry market kit for visual board - \$45
- DMRT01: Replace fabric panels with dry marker/erase board - \$95
- FC20: Flip Chart 34" x 20" - \$55 each

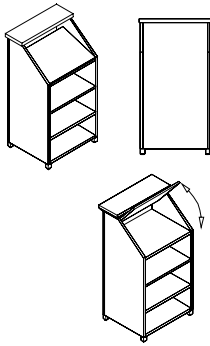

NEW LECTERN

STANDARD FEATURES

- 2 Adjustable shelves
- Lectern surface tilts up for storage

[CLICK HERE TO VIEW PRODUCT INDEX](#)

1 SELECT A STYLE

DIMENSIONS		STYLE NUMBER	LIST PRICE	STYLE NUMBER	LIST PRICE	STYLE NUMBER	LIST PRICE
W" x D" x H"	WGT	"W" Veneer Top Veneer Chassis		"G" High Pressure Laminate Top HPL Veneer Chassis		"M" Thermally Fused Laminate Top TFL Thermally Fused Laminate Chassis	
24 x 24 x 46	130	SPC2424LC499W	2990	"G" Option N/A		"M" Option N/A	

2 SELECT A FINISH **3 SELECT AN EDGE** **5 OPTIONS**

"W" Veneer	"G" HPL	"M" TFL	
WAC	-	-	Amber Cherry
WRC	-	-	Caramel Cherry
WIC	-	-	Crimson Cherry
WEC	-	-	Ebony Cherry
WHC	-	-	Honey Cherry
WOC	-	-	KoKo Cherry
WSC	-	-	Scotch Cherry
WAM	-	-	Alabaster Maple
WCM	-	-	Clear Maple
WWM	-	-	Wheat Maple
WBO	-	-	Blush Oak
WMO	-	-	Mocha Oak
WTO	-	-	Toast Oak
WWO	-	-	Wheat Oak
WEW	-	-	Executive Walnut
WRW	-	-	Gray Luster Walnut
WGW	-	-	Gunstock Walnut
WJW	-	-	Judicial Walnut
WNW	-	-	Natural Walnut
WTW	-	-	Studio Teak Walnut
WOW	-	-	Clear Walnut
WWP	-	-	Designer White



4 SELECT HARDWARE

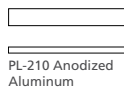

TABLE SHAPE		ROUND		RECTANGLE		SQUARE		ARCH RECTANGLE		BOAT SHAPE	
36 DIA.											
42 DIA.											
48 DIA.											
54 DIA.											
60 DIA.											
42 x 42	1										
48 x 48		1									
54 x 54			1								
60 x 60				1							
72 x 36					2						
84 x 42						2					
96 x 48							2				
120 x 48								*3			
144 x 48									*3		
168 x 54										3	
192 x 54											3
216 x 54											3
216 x 60											3
240 x 54											4
240 x 60											4



TABLE SHAPE		ROUND		RECTANGLE		SQUARE		ARCH RECTANGLE		BOAT SHAPE	
72 x 36/30	2										
84 x 42/32	2										
96 x 48/36		2									
120 x 48/39			2								
144 x 48/39				2+							
168 x 54/42					2+						
192 x 54/42						2+					
216 x 54/39							2+				
216 x 60/45								2+			
240 x 54/42									2+		
240 x 60/48										2+	

*Bases can be deleted when trough is specified.

TABLE SHAPE

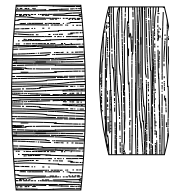
BOAT



72 x 36	2		
84 x 42	2		
96 x 48	2		
120 x 48	3		
144 x 48	3		
168 x 54	3		
192 x 54	3		
216 x 54	4		
216 x 60	4		
240 x 54	4		
240 x 60	4		

RFB2512MB986

RFB4222MB986

RECTANGLE

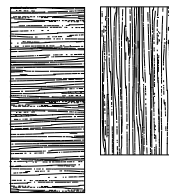

72 x 36	2		
84 x 42	2		
96 x 48	2		
120 x 48	3		
144 x 48	3		
168 x 54	3		
192 x 54	3		
216 x 54	4		
216 x 60	4		
240 x 54	4		
240 x 60	4		

BASE MODIFICATIONS

RUNOFF SLEIGH BASE

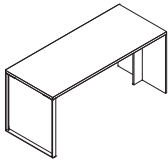

STYLE NUMBER	LIST PRICE	SPECIFICATIONS
24" Metal Sleigh Base SSB24	450	- Metal Sleigh base - standard in silver finish
30" Metal Sleigh Base SSB30	475	
36" Metal Sleigh Base SSB36	495	

Available: - Central, NOT SO square, Spaces

COMPUTER SUPPORT

DELUXE SINGLE MONITOR ARM W/ USB POST



STYLE NUMBER	LIST PRICE	SPECIFICATIONS
MA1952	495	<ul style="list-style-type: none"> - (4) 2.0 USB Ports - Post Length: 22-1/2"H, Post Base Requires 80mm Dia. Hole - Spring Assist - Full Movement Arm, Arm Extends Up To 13 - 3/8" - Supports Screens Up To 24", Swivels 180 degrees - Mount Plate Tilts 85 degrees - Arm: Die Cast Aluminum <p>Notes</p> <ul style="list-style-type: none"> - Surface Factory Bored / Ready To Install

Available: - All DARRAN Collections

COMPUTER SUPPORT

DELUXE DOUBLE MONITOR ARM W/ USB POST



STYLE NUMBER	LIST PRICE	SPECIFICATIONS
MA2952	795	<ul style="list-style-type: none"> - (4) 2.0 USB Ports - Post Length: 22-1/2"H, Post Base Requires 80mm Dia. Hole - Spring Assist - Full Movement Arm, Arm Extends Up To 13 - 3/8" - Supports Screens Up To 24", Swivels 180 degrees - Mount Plate Tilts 85 degrees - Arm: Die Cast Aluminum <p>Notes</p> <ul style="list-style-type: none"> - Surface Factory Bored / Ready To Install - Can Accommodate Up To 4 Monitors By Ordering Extra Double Arms. 1 Extra Arm and 1 Double Clamp - Add\$305

Available: - All DARRAN Collections

COMPUTER SUPPORT

CPU RETRACTABLE CRADLE

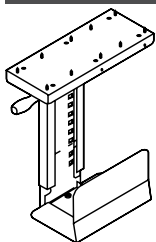

STYLE NUMBER	LIST PRICE	SPECIFICATIONS
K18	195	<ul style="list-style-type: none"> - Black Metal CPU Carriage - Full 360° swivel capability allows easy access to rear of CPU for cables / wires - Track allows 8- 1/2" extension - Width Adjustment 5-1/2" to 9-1/4" - Height adjustment 14- 5/8" to 20- 1/2" - Black epoxy finish <p>Notes</p> <ul style="list-style-type: none"> - Factory Installed

Available: - All DARRAN Collections

COMPUTER SUPPORT

ARTICULATING KEYBOARD TRAY

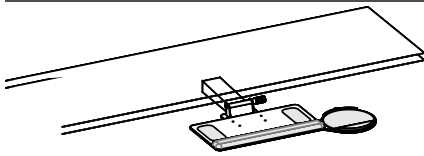

STYLE NUMBER

Factory Installed

K28

Field Installed

K28F

LIST PRICE

375

395

SPECIFICATIONS

- Adjusts effortlessly - A simple one-handed motion allows the keyboard to be repositioned instantly, without the use of locks or levers
- Encourages low-risk postures - Maximizes adjustability within a safe operating range.
- Will last a lifetime - Exceeds all applicable BIFMA Standards and comes with a lifetime guarantee.

Notes

- Factory Installed (standard)
- FIELD INSTALL - \$395

Available: - All DARRAN Collections

COMPUTER SUPPORT

TRADITIONAL PULL-OUT DRAWER WITH KEYBOARD TRAY

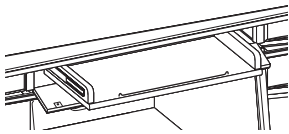

STYLE NUMBER

K21

LIST PRICE

450

SPECIFICATIONS

- Traditional Pull-out Drawer w/Keyboard Tray

Available: - Jamestown

CONFERENCE DESK SUPPORT POST OPTIONS

WOOD DRUM



STYLE NUMBER

6" Diameter Drum

B6

LIST PRICE

395

SPECIFICATIONS

- Available in Walnut / Cherry / Maple
- Adjustable levelers
- Replaces standard metal round legs

Notes

- Specify Finish

Available: - Central Park, NOT SO square

CONFERENCE DESK SUPPORT POST OPTIONS

WOOD HALF DRUM

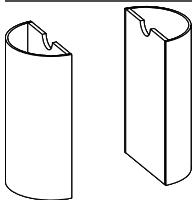

STYLE NUMBER

8" Half Drum

HC08

16" Diameter Drum

HC16

LIST PRICE

695

895

SPECIFICATIONS

- Available in Walnut / Cherry / Maple
- Adjustable levelers

Notes

- Specify Finish

Available: - Central Park, NOT SO square, Richmond Park

CONFERENCE DESK SUPPORT POST OPTIONS

METAL OVAL "T" BASE



STYLE NUMBER

Silver

32MOTS

Black

32MOTB

LIST PRICE

595

595

SPECIFICATIONS

- 3" x 1" Aluminum square extrusion
- Leveler adjustment
- Oval Post

Available: - Silver or Black

DOOR MODIFICATIONS

SOFT CLOSE DOOR HINGE



STYLE NUMBER

D9SC

LIST PRICE

15 Per Door

SPECIFICATIONS

- Snap onto standard door hinge
- Requires (1) per door
- Max door height 43"
- Factory installed where specified
- Individually shipped for field installation

Notes

- Specify Each Item To Have Slow Close Feature

Available: - All DARRAN Collections

DOOR MODIFICATIONS

DELETE DOORS

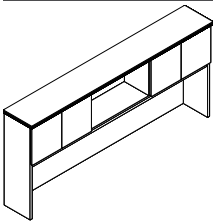

STYLE NUMBER

D6

LIST PRICE

N/C

SPECIFICATIONS

- Standard Door overheads and cabinets can have door deleted for open access. Modification of hinge rails and structural components are made face ready.

Available: - All DARRAN Collections

DOOR MODIFICATIONS

- REPLACE GLASS PANEL INSERT WITH VENEER PANEL INSERT



Glass Door

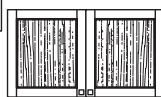

Wood Door

STYLE NUMBER

D35

LIST PRICE

30 per door

SPECIFICATIONS

- Replace glass panel insert with veneer panel insert

Notes

- Not Available on "M" skus
- Glass door has beveled glass
- Wood door w/ veneer insert - only available on "W" style

Available: - Capitol Park, Jamestown, Prado, Richmond Park

DOOR MODIFICATIONS

DELETE DOORS/REPLACE BLACK LAMINATE SHELF W/ FINISHED SHELF

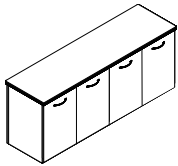

STYLE NUMBER
D6A

LIST PRICE
N/C

SPECIFICATIONS
- Delete doors and replace black laminate shelf with finished shelf

Available: - All Storage Credenzas ("W"/"G" Styles).
Excludes Rail.

DOOR MODIFICATIONS

PANEL DOOR LOCK

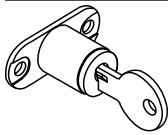

STYLE NUMBER
D2

LIST PRICE
95 Per Door Set

SPECIFICATIONS
- Door Locks - 1 Door w/ Lock, Other Door w/ Catch Latch
- Contact Customer Service regarding limited lock locations and keying.

Available: - Panel Doors, Wood Frame Doors, and Silverluma doors

DOOR MODIFICATIONS

GLASS DOOR LOCK

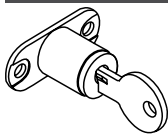

STYLE NUMBER
D2-G

LIST PRICE
195 Per Door Set

SPECIFICATIONS
- Door Locks - 1 Door w/ Lock, Other Door w/ Catch Latch
- Contact Customer Service regarding limited lock locations and keying.

Available: - Glass Doors

DOOR MODIFICATIONS

BOX DRAWER ACCESSORIES

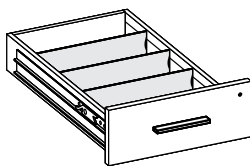

STYLE NUMBER
Wood Drawer Dividers w/ Clips
K-DIV
Single Tray - Utility Tray
K-Sut

LIST PRICE
SET OF 3 - 30
30 each

SPECIFICATIONS
- K-DIV Extra Wood Drawer Dividers with Clips, Top Box drawers standard with 1 divider
- K-SUT Single Tray - Utility Tray, Specify Legal or Letter drawer width

Available: - All DARRAN Collections. Excludes Rail.

DRAWER OPTIONS

TRADITIONAL CENTER DRAWER

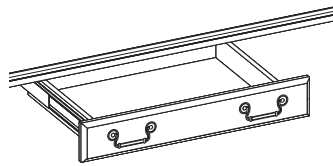

STYLE NUMBER
K17
Add Skirt Option
K17-SK

LIST PRICE
225

325

SPECIFICATIONS
- Standard on desks in Jamestown Collection. Optional center drawers available for bullet conference desk, kneespace credenzas and corner units. 3 ply hardwood drawer / dowel construction profile shaped drawer front. Specify pull choice.

Available: - Jamestown

DRAWER OPTIONS

FINISHED TRADITIONAL CENTER DRAWER

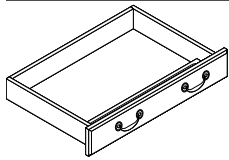

STYLE NUMBER
K30
Add Skirt Option
K30-SK

LIST PRICE
195

295

SPECIFICATIONS
- Veneer drawer front finished to match unit veneer. Edges are scalloped to match standard drawers.
- Standard with matching wood grain pencil tray
- Pulls selected to match unit installed

Available: - Richmond Park

DRAWER OPTIONS

FINISHED CENTER DRAWER

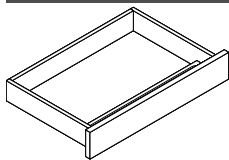

STYLE NUMBER
K31
Add Skirt Option
K31-SK

LIST PRICE
195

295

SPECIFICATIONS
- Veneer drawer front finished to match unit W or G style veneer.
- Ball bearing smooth operation
- Drawer has lifetime guarantee
- Standard with matching wood grain pencil tray
- Laminate drawer front to match laminate unit (M style)

Available: - Central Park, NOT SO square, Rail

DRAWER OPTIONS

PRADO/SPACES CENTER DRAWER - VENEER BOTTOM

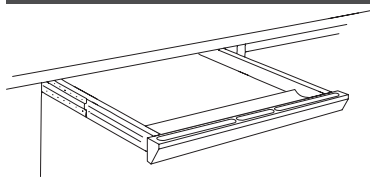

STYLE NUMBER
Factory Installed
K1
Field Installed
K1BVF

LIST PRICE
275

275

SPECIFICATIONS
- Solid hardwood front beveled and rounded with recessed pencil tray.

Available: - Prado, Spaces

DRAWER OPTIONS

CENTER DRAWER

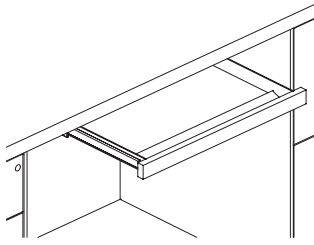

STYLE NUMBER

LIST PRICE

SPECIFICATIONS

Factory Installed

- Center Drawer - Factory Installed, Center Drawer - Field Installed

K1R

275

Field Installed

K1RF

275

Available: - Rift

DRAWER OPTIONS

CENTER DRAWER WITH SKIRT

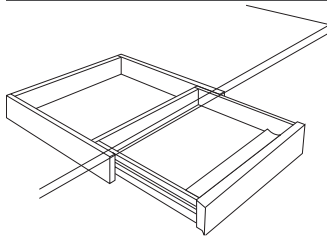

STYLE NUMBER

LIST PRICE

SPECIFICATIONS

Factory Installed

- Center Drawer - Factory Installed, Center Drawer - Field Installed

K2R

375

Field Installed

K2RF

375

Add Skirt Option

K2R-SK

475

Available: - Rift

DRAWER OPTIONS - BOTTOM COVER

BLACK DURA-LEATHER DRAWER BOTTOM COVERS

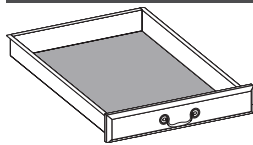

STYLE NUMBER

LIST PRICE

SPECIFICATIONS

P2

75

- Center drawer and Box/Tray drawers are covered in Black Duraleather that adds a prestigious touch.

Available: - Jamestown

DRAWER OPTIONS - BOTTOM COVER

FELT BOTTOM CENTER DRAWER INSERT LINER

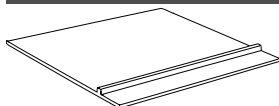

STYLE NUMBER

LIST PRICE

SPECIFICATIONS

K3

95

- Inserts into center drawer and features divider for open pen and pencil storage. Removable for easy cleaning.
- Adds a luxurious touch to center drawers.
- Color: Dark Brown Coal

Available: - All DARRAN Collections. Excludes Rail.

DRAWER OPTIONS - UPGRADE

WOOD DRAWER UPGRADE

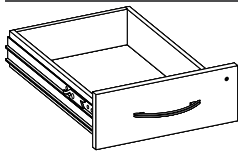

STYLE NUMBER
P33

LIST PRICE
40 Per Drawer

SPECIFICATIONS

- Dowel joint construction
- Hardwood veneer multi-ply drawer
- UV finish
- 1/4" Wood veneer bottoms
- File drawer bottoms are fiv block reinforced for heavy weight capacity
- Lifetime guaranteed

Available: - Central Park, Capitol Park, NOT SO square, Rail, Richmond Park

LIGHTING

LT-LED TASK LIGHT

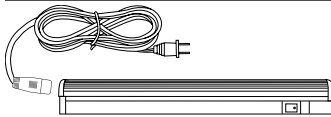

STYLE NUMBER
24" Tasklight
LT-LED24
48" Tasklight
LT-LED48
60" Tasklight
LT-LED60
Linking Cable
LC22

LIST PRICE
90
165
180
20

SPECIFICATIONS

- Anodized aluminum finish
- Tilting beam allows adjustability
- Switch with dimming control
- 50,000 hour life
- 12V power drive standard with each task light 30 watt max

Notes
- LC22: 20" LT-LED Task light linking cable

Available: - All DARRAN Collections

LIGHTING

DELETE TASK LIGHT CONCEALMENT APRON RAIL

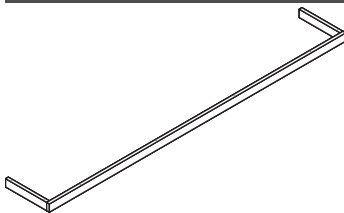

STYLE NUMBER
WAR-D

LIST PRICE
Deduct 125

SPECIFICATIONS
- Delete Tasklight Concealment apron rail when a task light is not used on a wall hung unit

Available: - Wall Hung Units

LIGHTING

SLIM LINE ALUMINUM LED TASK LIGHT

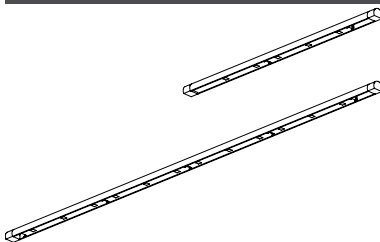

STYLE NUMBER
24" Tasklight
LED24
48" Tasklight
LED48
60" Tasklight
LED60
Linking Package
DPC

LIST PRICE
315
445
555
Deduct 85 per task light

SPECIFICATIONS

- Anodized aluminum finish
- Tilting beam allows adjustability
- Switch with dimming control
- 50,000 hour life
- 12V power drive standard with each task light 30 watt max

Notes
- Link multiple tasklights up to 30W of power wattage. Deletes 1 power drive

Available: - Rift and Spaces

LIGHTING

LED INTERIOR CABINET PUCK LIGHT

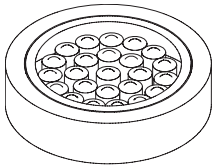

STYLE NUMBER

LIST PRICE

SPECIFICATIONS

Starter Kit
LEDPK
1 LED Interior Puck Light
PK

295

125

- Starter kit includes Infeed, 1 Puck Interior Light and the ability to daisy chain up to 6 total Puck Lights
- (1) LED Puck Light with 30W power drive and switch
- Recessed fixture
- 12V linking cord 98"L
- Silver finish
- 50,000 hour life
- 2 watt per light

Notes

- Power drive included, Light only

Available: - Overhead/Tower Units with glass doors or no doors

PEDESTAL MODIFICATIONS

BREAKFRONT PEDESTAL WITH WIRE MANAGEMENT CAVITY DOOR

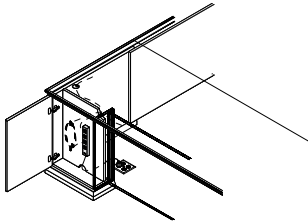

STYLE NUMBER

LIST PRICE

SPECIFICATIONS

PC10
Power Supply Cordset
PD717

95

95

- Hinged pedestal front door offers easy access for wire management
- Wire hooks provide wire coil storage
- Wire access openings allow access to floor, cabinets interior and kneespace
- Cabinet interior is black finish
- Top grommet is positioned over cavity for access ease
- (Power Strip Optional)

Notes

- Breakfront Chassis Only

Available: - All DARRAN Collections. Excludes Jamestown, Rail, Richmond, and Rift.

PEDESTAL MODIFICATIONS

BLACK LAMINATE PRINTER PULLOUT BOTTOM SHELF

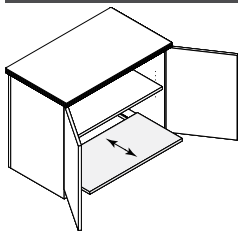

STYLE NUMBER

LIST PRICE

SPECIFICATIONS

PPOS

214

- Black Laminate pullout shelf on suspension
- Black grommet
- Adjustable Shelf

Available: - All DARRAN Collections. Excludes Rail.

PEDESTAL MODIFICATIONS

ADD VENEER KNEESPACE CABINETS - BASE

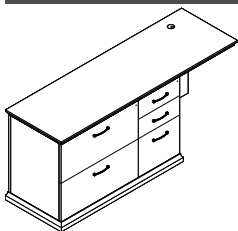

STYLE NUMBER

LIST PRICE

SPECIFICATIONS

Add Box/Box/File or File/File

P40B

985

- Multi-file specify Box/Box Left or Right

Add Lateral File 29" W

P41B

1205

Notes

- Add additional Standard Cabinets To Kneespace Area.

Add Multi-File - 31"W

P42B

1205

Add Storage With Doors 29"W

P43B

1095

Add CPU /Printer Cabinet - Open

P44B

1095

Available: - Capitol Park, Jamestown, Prado, Richmond Park

PEDESTAL MODIFICATIONS

ADD VENEER KNEESPACE CABINETS - NO BASE

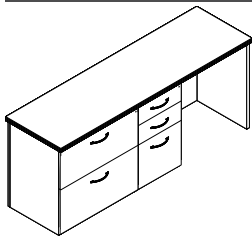

Available: - Central Park, NOT SO square

STYLE NUMBER	LIST PRICE
<i>Add Box/Box/File or File/File</i> P40W	875
<i>Add Lateral File 29" W</i> P41W	985
<i>Add Multi-File - 31"W</i> P42W	1095
<i>Add Storage With Doors 29"W</i> P43W	985
<i>Add CPU /Printer Cabinet - Open</i> P44W	985

SPECIFICATIONS
- Multi-file specify Box/Box Left or Right

Notes
- Add additional Standard Cabinets To Kneespace Area.

PEDESTAL MODIFICATIONS

ADD TECH VENEER KNEESPACE CABINETS - NO BASE

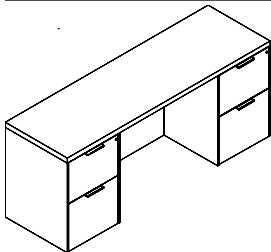

Available: - Rift

STYLE NUMBER	LIST PRICE
<i>Add Box/Box/File or File/File</i> P40T	1100
<i>Add Lateral File 29" W</i> P41T	1210
<i>Add Multi-File - 31"W</i> P42T	1320
<i>Add Storage With Doors 29"W</i> P43T	1210
<i>Add CPU /Printer Cabinet - Open</i> P44T	1210

SPECIFICATIONS
- Multi-file specify Box/Box Left or Right

Notes
- Add additional Standard Cabinets To Kneespace Area.

PEDESTAL MODIFICATIONS

ADD MELAMINE (TFL) KNEESPACE CABINETS - NO BASE

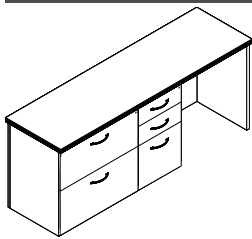

Available: - Central Park (TFL) and NOT SO square (TFL)

STYLE NUMBER	LIST PRICE
<i>Add Box/Box/File or File/File</i> P40M	688
<i>Add Lateral File 29" W</i> P41M	853
<i>Add Multi-File - 31"W</i> P42M	963
<i>Add Storage With Doors 29"W</i> P43M	765
<i>Add CPU /Printer Cabinet - Open</i> P44M	875

SPECIFICATIONS
- Multi-file specify Box/Box Left or Right

Notes
- Add additional Standard Cabinets To Kneespace Area.

PEDESTAL MODIFICATIONS

MODIFY DRAWER CONFIGURATIONS

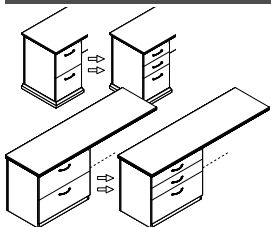

Available: - All DARRAN Collections. Excludes Rail.

STYLE NUMBER	LIST PRICE
<i>File/File to Box/Box/File</i> P6	50 per pedestal
<i>Box/Box/File to File/File</i> P6	50 per pedestal
<i>Lateral File to 2 Box Drawers</i> P8	95 per pedestal

SPECIFICATIONS
- Modify File/File To Box/Box/File - Any Unit

PEDESTAL MODIFICATIONS

MODIFY DRAWER CONFIGURATIONS

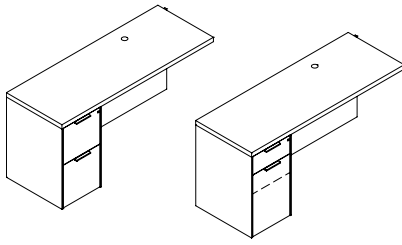

STYLE NUMBER

File/File to Box/Box/File

P6H

Lateral File to 2 Box Drawers

P8

LIST PRICE

95 per pedestal

95 per pedestal

SPECIFICATIONS

- Modify File/File To Box/Hidden Box/File - Any Unit

Available: - Rift

POWER / DATA

POWER SUPPLY CORDSET

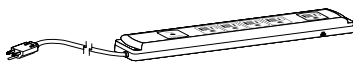

STYLE NUMBER

PD717

LIST PRICE

95

SPECIFICATIONS

- SIZE: 10.75"L x 2.0"W x 1.06"H

- (5) Outlets w/ 10' cord

- Surge suppression (720 Joules)

- 15 Amp breaker

- Available on: Vertical Panels, Cabinet Interiors, and under tops

Available: - All DARRAN Collections

PRODUCT MODIFICATIONS

MODIFY WIDTH - OPEN KNEESPACE

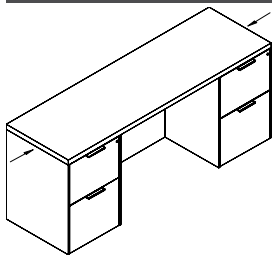

STYLE NUMBER

MOD-1

LIST PRICE

125

SPECIFICATIONS

- Modify width down on any unit with an open knee space: desk, workstation credenza, bridge, return

Available: - All DARRAN Collections

PRODUCT MODIFICATIONS

MODIFY WIDTH - OPEN/CLOSED STORAGE

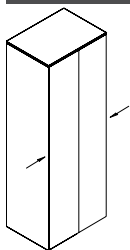

STYLE NUMBER

MOD-2

LIST PRICE

250

SPECIFICATIONS

- Modify width down on any unit with open or closed storage section: overheads, wall hung units, storage credenzas, towers

Available: - All DARRAN Collections

PRODUCT MODIFICATIONS

MODIFY WIDTH - OUTSIDE OF MOD-1, MOD-2

STYLE NUMBER

MOD-3

LIST PRICE

Contact Factory for Pricing

SPECIFICATIONS

- Width modification outside of MOD-1 & MOD-2

Available: - All DARRAN Collections

PRODUCT MODIFICATIONS

MODIFY WIDTH - TACKBOARD, SLAT WALL, VENEER PANEL, OR A GLASSBOARD

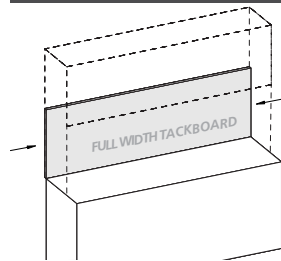

STYLE NUMBER

MOD-4

LIST PRICE

50

SPECIFICATIONS

- Modify width down on tackboard, slat wall, veneer panel, or a overhead glassboard

Available: - All DARRAN Collections

PRODUCT MODIFICATIONS

MODIFY DEPTH - DECREASE DEPTH

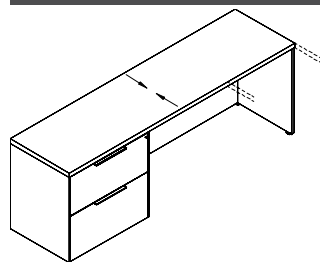

STYLE NUMBER

MOD-5

LIST PRICE

125

SPECIFICATIONS

- Modify depth down (minimum depth for a unit with drawers is 21"D)

Notes

- Ex. 24" to 21", 30" to 24", and 36" to 30"

Available: - All DARRAN Collections

PRODUCT MODIFICATIONS

MODIFY DEPTH - INCREASE DEPTH

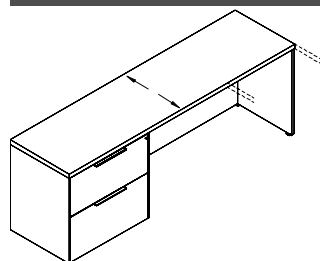

STYLE NUMBER

MOD-6

LIST PRICE

Add 10%

SPECIFICATIONS

- Increase depth

Notes

- Ex. 24" to 30", 30" to 36", and 36" to 42"

Available: - All DARRAN Collections. Excludes Rift.

PRODUCT MODIFICATIONS *MODIFY HEIGHT*

STYLE NUMBER	LIST PRICE	SPECIFICATIONS
MOD-7	Contact Factory for Pricing	- Modify height of a unit

Available: - All DARRAN Collections

PRODUCT MODIFICATIONS *MODIFY CONFERENCE TABLE LENGTH AND WIDTH - 1 PIECE TOP*

STYLE NUMBER	LIST PRICE	SPECIFICATIONS
MOD-8	125	- Modify length/width down on a 1 piece table top

Available: - Conferencing

PRODUCT MODIFICATIONS *MODIFY CONFERENCE TABLE LENGTH AND WIDTH - 2/3 PIECE TOP*

STYLE NUMBER	LIST PRICE	SPECIFICATIONS
MOD-9	250	- Modify length/width down on a 2 or 3 piece table top

Available: - Conferencing

REFRIGERATOR MODIFICATION *REFRIGERATOR CABINET MODIFICATION*

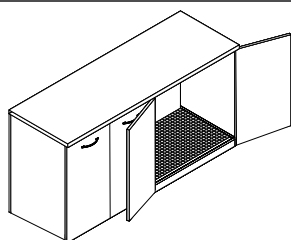

STYLE NUMBER	LIST PRICE	SPECIFICATIONS
REF01	195	<ul style="list-style-type: none"> - Open back cutout for venting - Moisture sponge mat - Contaminate ledge - Contact customer service for maximum refrigerator size (Changes based on unit).

Available: - Storage Credenzas

SHAPED TOPS **OVERHEAD/WALL HUNG SHAPED TOP**

STYLE NUMBER	LIST PRICE	SPECIFICATIONS
99"W - 105"W		- Shaped tops for overheads and wall hungs
TOH-1	405	
58"W - 93"W		
TOH-2	315	
29"W - 47"W		
TOH-3	203	

Available: - Central Park, Rail

SHAPED TOPS **BOOKCASE SHAPED TOP**

STYLE NUMBER	LIST PRICE	SPECIFICATIONS
29"W - 35"W x 15"D		- 15" D Shaped tops for bookcases
TOH-4	203	- Shaped on front

Available: - Central Park, Rail

SHAPED TOPS **TOWER SHAPED TOP**

STYLE NUMBER	LIST PRICE	SPECIFICATIONS
16" Single Width Tower		- 24" deep shaped tops for towers
TOH-5	158	- Shaped on front
29"W - 46"W Tower		
TOH-6	203	

Available: - Central Park, Rail

SHAPED TOPS **WORKSURFACE SHAPED TOP**

STYLE NUMBER	LIST PRICE	SPECIFICATIONS
Shape Four Sides		- S4S Applies to desk, bridge or any freestanding unit. This adds shapes or copes to two sides (desk, bridges) or one side and back of units (returns).
S4S	50	
Shape Three Sides		- S3S Applies to credenza units. This adds shapes to the two sides.
S3S	50	- Credenzas are shaped front standard with flat back
		Notes
		- Desk, Freestanding and Credenza units will grow 1" in width due to adding shapes on ends of units.

Available: - Central Park

SHAPED TOPS

PREMIUM EDGE - SHAPED WORKSURFACE TOP

STYLE NUMBER	LIST PRICE	SPECIFICATIONS
<i>Shape Four Sides Premium Edge</i>		
S4S-PE	Add 10%	- S4S-PE Applies to desk, bridge or any freestanding unit. This adds shapes or copes to two sides (desk, bridges) or one side and back with hardwood rims (returns).
<i>Shape Three Sides Premium Edge</i>		
S3S-PE	Add 10%	- S3S-PE Shape Three Sides Premium Edge. Applies to credenza units. This adds shape to the two sides with hardwood rims.
Notes		
- Desk, Freestanding and Credenza units will grow 1" in width due to adding shapes on ends of units.		

* 10% Upcharge includes 5% for premium edge

Available: - Central Park

SHELF MODIFICATIONS

GLASS SHELVES - TEMPERED FULL WIDTH 26" - 35"

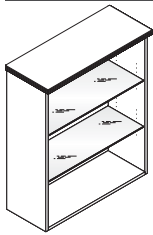

STYLE NUMBER	LIST PRICE	SPECIFICATIONS
<i>26"W - 35"W x 14"D Shelf</i>		
GS14F	85	- Glass Shelves Replace Wood Shelf In Open Or Glass Door Cabinet. Also Order Interior Cabinet Lighting.

Available: - All DARRAN Collections

SHELF MODIFICATIONS

TEMPERED GLASS SHELVES FOR HALF CABINET 17- 1/2" WIDTHS

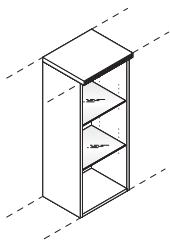

STYLE NUMBER	LIST PRICE	SPECIFICATIONS
<i>14-1/2"W - 17- 1/2"W x 14"D Shelf</i>		
GS14H	65 ea	- Glass Shelves Replace Wood Shelf In Open Or Glass Door Cabinet. Also Order Interior Cabinet Lighting.

Notes
- Replace only adjustable shelves between cabinet light and fixed lower wood shelf.

Available: - All DARRAN Collections

SHELF MODIFICATIONS

CURVED CORNER GLASS SHELF

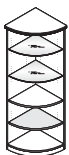

STYLE NUMBER	LIST PRICE	SPECIFICATIONS
GS14CC	85 ea	- Curved shelves feature glass retainer clips to prevent tipping
Notes		
- Replace only adjustable shelves between cabinet light and fixed lower wood shelf.		

Available: - All DARRAN Collections. Excludes Rail.

SHELF MODIFICATIONS

HEAVY DUTY SOLID WOOD BOOKCASE REPLACEMENT SHELVES

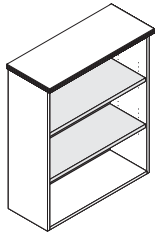

STYLE NUMBER
1" Wood Shelf 14" Deep
 S714F
1" Wood Shelf 24" Deep
 S714FX

LIST PRICE
 75 ea
 150 each

SPECIFICATIONS
 - 1" Solid Lumber Core Shelves Replace Standard 3/4" Plywood
 Adjustable And Fixed Shelves

Available: - All DARRAN Collections. Excludes Rail.

SLAT WALL ACCESSORIES

SLAT WALL ACCESSORY TRAY

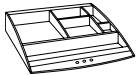

STYLE NUMBER
 SWA9

LIST PRICE
 45

SPECIFICATIONS
 - Specify Black Or Matte Silver

Available: - All DARRAN Collections. Excludes Rail.

SLAT WALL ACCESSORIES

SLAT WALL FOLDER TRAY



STYLE NUMBER
 SWA7

LIST PRICE
 45

SPECIFICATIONS
 - Specify Black Or Matte Silver

Available: - All DARRAN Collections. Excludes Rail.

SLAT WALL ACCESSORIES

SLAT WALL PAPER TRAY



STYLE NUMBER
 SWA2

LIST PRICE
 35

SPECIFICATIONS
 - Specify Black Or Matte Silver

Available: - All DARRAN Collections. Excludes Rail.

SLAT WALL ACCESSORIES

SLAT WALL PENCIL HOLDER



STYLE NUMBER
SWA4

LIST PRICE
25

SPECIFICATIONS
- Specify Black Or Matte Silver

Available: - All DARRAN Collections. Excludes Rail.

SPECIALTY VENEER ACCENTS

BLACK EBONY WOOD INLAY IN ONE PIECE CONFERENCE TOP

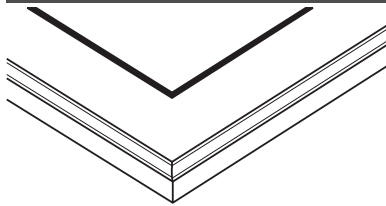

STYLE NUMBER
One Piece Conference Top
T30
Two Piece Conference Top
T31

LIST PRICE
735
1480

SPECIFICATIONS
- Standard veneer top is routed for Ebony wood inlay 1/8" x 3/16" width line. Inlay wood is miter jointed in the corners, hand fitted, glued and sanded flush with top veneer. Inlay forms a 3" border to top edge

Notes
- Hand fitted miter corner Black Ebony wood inlay installed in standard wood veneer tops

Available: - Conferencing Tops.

SPECIALTY VENEER ACCENTS

BLACK/WHITE/BLACK WOOD INLAY

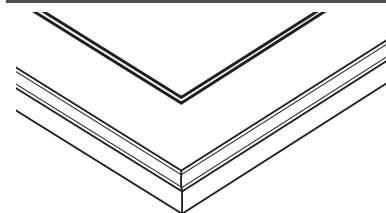

STYLE NUMBER
One Piece Top
T30BWB
Two Piece Top
T31BWB

LIST PRICE
950
1795

SPECIFICATIONS
- Standard veneer top is routed for wood inlay 1/8" x 3/16" width line. Each color is 1/16" wide. White inlay line is finished over providing a subtle contrast to line detail

Notes
- Hand fitted miter corner ebony-maple-ebony wood inlay installed in standard veneer top
- The center white line can be masked off preventing color stains from penetrating. Final top coats are applied over the white line.

Available: - Conferencing Tops

SPECIALTY VENEER ACCENTS

BLACK EBONY WOOD INLAY W/ WOOD FAN DETAIL - 1 PIECE CONFERENCE TABLE TOP

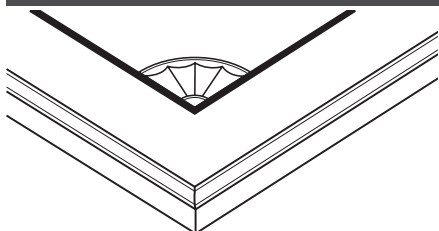

STYLE NUMBER
One Piece Top
T51
Two Piece Top
T52

LIST PRICE
1160
2110

SPECIFICATIONS
- Standard veneer top is routed for wood inlay 1/8" x 3/16" width line. With each 90 degree corner routed for Quarter circle fan inlays. Inlay fans combined with solid black inlay preserves an old traditional appearance. Fans are handcrafted from teakwood, rosewood, mahogany, and other exotic woods. Each piece of veneer is shaded by burning and is hand fitted to a perfect fan shape - truly and old world craft
- Conference tables: 4 fans, one in each corner per top section

Notes
- Hand fitted miter corner wood inlay and fan installed in standard veneer top
- Only available on square/ rectangle tops

Available: - Conferencing Tops

SPECIALTY VENEER ACCENTS

CROTCH MAHOGANY INFIELD WITH MITERED BORDER



STYLE NUMBER

- TCB-1 - 84 x 36/42
- TCB-2 - 72 x 36/42
- TCB-3 - 72 x 30/36

LIST PRICE

- 1895
- 1795
- 1695

SPECIFICATIONS

- Center balanced butt and book matched crotch mahogany
- 35 sheen non-rubbed finish ensures maximum durability

Available: - Jamestown, Prado

SPECIALTY VENEER ACCENTS

CROTCH MAHOGANY DESK PEDESTAL FRONTS

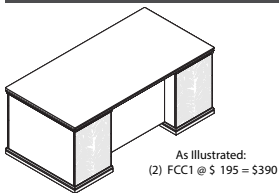

Desk Approach
Pedestal Fronts

STYLE NUMBER

FCC1

LIST PRICE

195 per pedestal

SPECIFICATIONS

- Center balanced butt and book matched crotch mahogany
- 35 sheen non-rubbed finish ensures maximum durability

Available: - Jamestown, Prado

SPECIALTY VENEER ACCENTS

CROTCH MAHOGANY DRAWER FRONTS

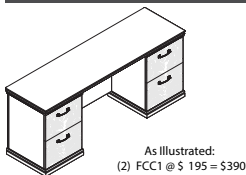

Box/Box/File or File/File
Drawer Fronts

STYLE NUMBER

FCC1

LIST PRICE

195 per pedestal

SPECIFICATIONS

- Center balanced butt and book matched crotch mahogany
- 35 sheen non-rubbed finish ensures maximum durability

Available: - Jamestown, Prado

SPECIALTY VENEER ACCENTS

CROTCH MAHOGANY DOUBLE WIDTH PANEL FRONTS



All Three Illustrations Represent: (1) FCC2 @ \$395

30-32-36 Width
FCC-2 \$395 per Panel Set

STYLE NUMBER

FCC2

LIST PRICE

395 per Panel Set

SPECIFICATIONS

- Center balanced butt and book matched crotch mahogany
- 35 sheen non-rubbed finish ensures maximum durability

Available: - Jamestown, Prado

SPECIALTY VENEER ACCENTS

CROTCH MAHOGANY DOUBLE WIDTH/ DOUBLE HEIGHT FRONTS



STYLE NUMBER
FCC3

LIST PRICE
895 per Panel Set

SPECIFICATIONS
- Center balanced butt and book matched crotch mahogany
- 35 sheen non-rubbed finish ensures maximum durability

Both Illustrations Represent:
(1) FCC3 @ \$895 - Panel Set
52" Center Balance Butt & Bookmatch
30-36 Width
FCC-3 \$895 per Panel Set

Available: - Jamestown, Prado

SPECIALTY VENEER ACCENTS

RECTANGLE INLAY - RECESSES DURA-LEATHER WRITING SURFACE

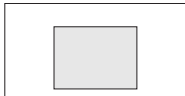

RECTANGLE INLAY

STYLE NUMBER
RL-29A

LIST PRICE
895

SPECIFICATIONS
- Recessed inlay desk pads are covered with Alomost Leather from Paul Brayton Designs.
- DARRAN will gladly custom quote other inlay materials ie: solid surfaces, biocomposites, metallic laminates, or genuine leather to match seating

Available: - All DARRAN Collections

SPECIALTY VENEER ACCENTS

BOWFRONT INLAY - RECESSES DURA-LEATHER WRITING SURFACE

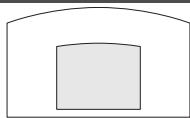

BOWFRONT INLAY

STYLE NUMBER
RL-31A

LIST PRICE
995

SPECIFICATIONS
- Recessed inlay desk pads are covered with Alomost Leather from Paul Brayton Designs.
- DARRAN will gladly custom quote other inlay materials ie: solid surfaces, biocomposites, metallic laminates, or genuine leather to match seating

Available: - All DARRAN Collections

SPECIALTY VENEER ACCENTS

RECTANGLE INLAY - EBONY HARDWOOD INLAY DETAIL

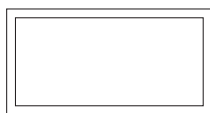

RECTANGLE INLAY

STYLE NUMBER
T10SA

LIST PRICE
895

SPECIFICATIONS
- 3/16" x 3/16" thick hardwood ebony inlay is handfitted and glued into routed top and sanded flush with surface
- Inlay is finished over with all finish steps

Notes
- Ebony inlay not recommended in: Koko Cherry

Available: - All DARRAN Collections

SPECIALTY VENEER ACCENTS

BOWFRONT INLAY - EBONY HARDWOOD INLAY DETAIL

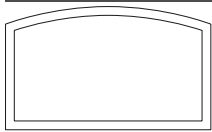

CURVED INLAY

STYLE NUMBER

T11SA

LIST PRICE

995

SPECIFICATIONS

- 3/16" x 3/16" thick hardwood ebony inlay is handfitted and glued into routed top and sanded flush with surface
- Inlay is finished over with all finish steps

Notes

- Ebony inlay not recommended in: Koko Cherry

Available: - All DARRAN Collections

TOOL CHANNEL ACCESSORIES

RECESSED ALUMINUM TOOL CHANNEL

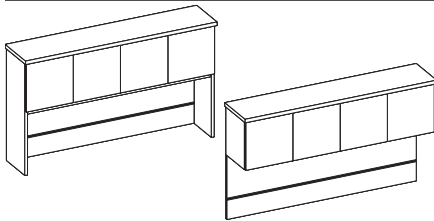

STYLE NUMBER

ATB02

LIST PRICE

5 per 1"W

SPECIFICATIONS

- Anodized aluminum finish
- Fully recessed
- Finish matches anodized aluminum accessories
- Can be specified with fabric tack surface mounted above channel

Notes

- If using tool channel with wallhung overhead, a veneer panel must be specified.

Available: - All DARRAN Collections. Excludes Rail.

TOOL CHANNEL ACCESSORIES

FILE HOLDER

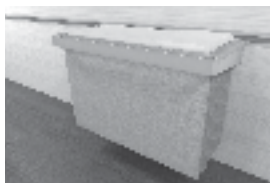

STYLE NUMBER

ATB37

LIST PRICE

105

SPECIFICATIONS

- For Console/Wall Hung Back Panels With Optional Tool Bar
- 18 Gauge Steel - Stamp Formed
- Silver Powderdercoat Finish

Available: - All DARRAN Collections. Excludes Rail.

TOOL CHANNEL ACCESSORIES

IPHONE HOLDER



STYLE NUMBER

ATB31

LIST PRICE

120

SPECIFICATIONS

- For Console/Wall Hung Back Panels With Optional Tool Bar
- 18 Gauge Steel - Stamp Formed
- Silver Powderdercoat Finish
- 5" x 3 -3/4"W
- Non-slip Neoprene pad

Available: - All DARRAN Collections. Excludes Rail.

TOOL CHANNEL ACCESSORIES

LARGE SHELF

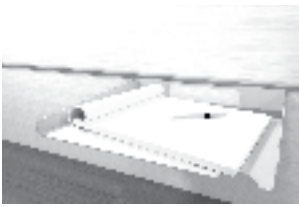

STYLE NUMBER
ATB35

LIST PRICE
125

SPECIFICATIONS
- 12"W x 10"D

Available: - All DARRAN Collections. Excludes Rail.

TOOL CHANNEL ACCESSORIES

PENCIL PEN HOLDER

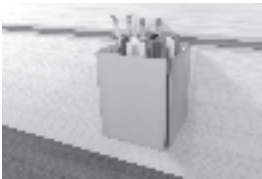

STYLE NUMBER
ATB38

LIST PRICE
115

SPECIFICATIONS
- For Console/Wall Hung Back Panels With Optional Tool Bar
- 18 Gauge Steel - Stamp Formed
- Silver Powdercoat Finish
- 5"H x 4"W x 4"D

Available: - All DARRAN Collections. Excludes Rail.

TOOL CHANNEL ACCESSORIES

SMALL SHELF



STYLE NUMBER
ATB36

LIST PRICE
110

SPECIFICATIONS
- 12"W x 6 -3/4"D

Available: - All DARRAN Collections. Excludes Rail.

TOOL CHANNEL ACCESSORIES

TABLET HOLDER

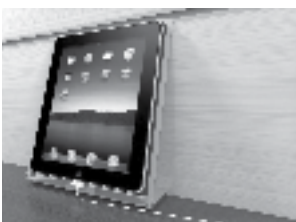

STYLE NUMBER
ATB30

LIST PRICE
135

SPECIFICATIONS
- For Console/Wall Hung Back Panels With Optional Tool Bar
- 18 Gauge Steel - Stamp Formed
- Silver Powdercoat Finish
- 10" x 8"W
- Non-slip Neoprene pad

Available: - All DARRAN Collections. Excludes Rail.

TOP MODIFICATION

1/4" RECTANGLE SOFT ETCH GLASS RUNOFF WORKSURFACE

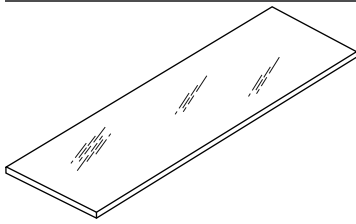

STYLE NUMBER

SEGW8436
 SEGW8430
 SEGW7836
 SEGW7830
 SEGW7230
 SEGW6630
 SEGW6030

LIST PRICE

2210
 1870
 2070
 1750
 1630
 1515
 1395

SPECIFICATIONS

- 1/4" Soft etch glass
 - Back painted white glass

Notes

- Additional colors can be custom quoted. Contact factory for pricing.

Available: - Rift Runoff Worksurface

TOP MODIFICATION

TOP APRON RAIL

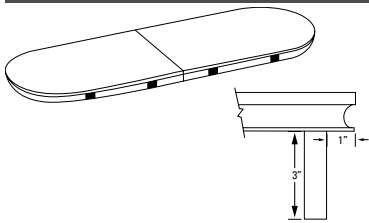

STYLE NUMBER

TAR

LIST PRICE

Add 10% to top price for apron only

SPECIFICATIONS

- 3 x 3/4 thick apron rail is set back under top 1"
 - Apron rail is recommended for fixed port installation for power/data support.

Notes

- Select power/data support separately.
 - See power options for available apron power: UDT2/VD-SM

Available: - Conferencing Tops Only

TOP MODIFICATION

TOP APRON RAIL

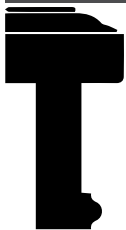

STYLE NUMBER

TAR-M

LIST PRICE

Add 15% (Apron rail with beltline detail)

SPECIFICATIONS

- Traditional with apron rail and molding - available in Cherry and Walnut.

Notes

- Select power/data support separately.
 - See power options for available apron power: UDT2/VD-SM

Available: - Conference tops only

WIRE MANAGEMENT

HORIZONTAL J-CHANNEL WIRE MANAGEMENT RACEWAY

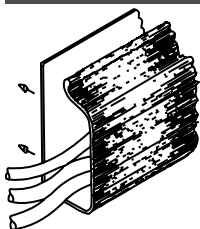

STYLE NUMBER

W1

LIST PRICE

75 Per 4 Foot Section

SPECIFICATIONS

- 4' section for field installation.
 - The "J" shape black thermoplastic wire raceway may be added to specified worksurface tops to provide concealed channeling of wires to and from worksurface grommets. For use in open kneespace areas, raceway is attachable to top of back panel with pan head screws. Interior dimensions are 1" x 1- 1/2" providing ample storage for multiple wires and excess cable. Front of raceway flexes out for easy cord insertion.

Notes

- Units w/ Wire Channel Standard.
 - Field Installation

Available: - All DARRAN Collections.

WIRE MANAGEMENT

HORIZONTAL U-CHANNEL WIRE MANAGEMENT RACEWAY



STYLE NUMBER
W2A

LIST PRICE
75 Per 4 Foot Section

SPECIFICATIONS
- 4' section for field installation.

Notes
- Units w/ Wire Channel Standard.
- Field Installation

Available: - All DARRAN Collections.

WIRE MANAGEMENT

COIL WIRE MANAGER



STYLE NUMBER
W18

LIST PRICE
150

SPECIFICATIONS
- Weighted Base, Table attachment plate
- 39- 1/2" Length
- Black

Notes
- Location

Available: - All DARRAN Collections.

WIRE MANAGEMENT

STANDARD LOCATION GROMMETS - FACTORY INSTALLED

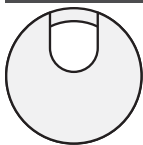

STYLE NUMBER
Standard Location Grommet

Black
TM30

Silver
TM31

Antique Brass
TM33

White
TM34

LIST PRICE

45

45

45

45

45

SPECIFICATIONS
- 1 -5/8" Metal Grommet

Notes
- *Units w/ Grommets Standard Are Noted Under Standard Features. Grommets Match Pull Finish - Standard (Unless Specified Otherwise)

Available: - All DARRAN Collections.

WIRE MANAGEMENT

NON-STANDARD LOCATION GROMMETS - FACTORY INSTALLED

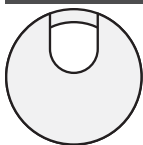

STYLE NUMBER
Non-Standard Location Grommet

Black
TM30 -NS

Silver
TM31 -NS

Antique Brass
TM33 -NS

White
TM34 -NS

LIST PRICE

90

90

90

90

90

SPECIFICATIONS
- 1 -5/8" Metal Grommet

Notes
- *Units w/ Grommets Standard Are Noted Under Standard Features. Grommets Match Pull Finish - Standard (Unless Specified Otherwise)

Available: - All DARRAN Collections

WIRE MANAGEMENT

BLACK PLASTIC VERTICAL SURFACE GROMMETS - FACTORY INSTALLED



STYLE NUMBER	LIST PRICE	SPECIFICATIONS
<i>Standard Location Grommet</i>		- 2 " Black Plastic Grommet
TM50-C	45	Notes - Standard Location is Bottom Center
<i>Non-Standard Location Grommet</i>		
TM50-NS	90	

Available: - All DARRAN Collections

WORKSTATION

CLIENT PULLOUT WRITING SHELF

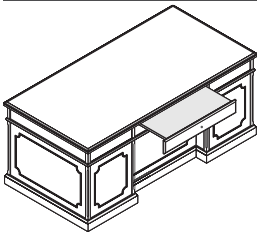

STYLE NUMBER	LIST PRICE	SPECIFICATIONS
CP-1	425	- CP-1: Client pull-out writing shelf for executive chassis desk
CP-2	625	- CP-2: Client pull-out writing shelf for conference desk

Available: - Jamestown

AIRCHARGE WIRELESS CHARGING GROMMET

STYLE NUMBER	LIST PRICE
ACWG WIRELESS GROMMET	\$575
ACWR WIRELESS RECEIVER W/ LIGHTNING CABLE	\$170



AirCharge Wireless Grommet

SPECIFICATIONS

- AirCharge offers a convenient way to charge any Qi compatible smartphone or device without the need to carry charging cables or find an available power outlet. Devices not equipped with the Qi technology, can be adapted to accept a charge from the grommet with the AirCharge Wireless Receiver.
- Size: 3.33" DIA x .75"D
- Compatible with an Qi rated device, Contact Customer Service for compatibility list
- Non-Qi device can be adapted to accept AirCharge unit with an ACWR AirCharge Wireless Receiver (compatible with iPhone)
- Surface Mount
- 78" Cord
- Standard Black Aluminum Finish; Available in White Aluminum or Black Finish upon request

AVAILABLE

- All Darran Collections



iphone w/ ACWR



Black Aluminum



Black Finish



White Aluminum

COVE POWER UNIT - NON-LINKING

STYLE NUMBER	LIST PRICE
 PD COVE PLUG Non-Linking Version	\$550

SPECIFICATIONS

- Size 5.75" L x 2.5" W
- (2) 15 Amp Receptacles and (2) USB charging ports
- Surface Mount
- 108" Cord
- Standard Silver Finish, Available in White or Black Finish upon request
- ETL Listed

AVAILABLE

- All Darran Collections



COVE POWER UNIT WITH DAISYLINK

STYLE NUMBER

LIST PRICE

STARTER UNITS



COV-DCH HARDWIRED

\$710

Includes (1) Cove unit with Hardwire Infeed - 120"



COV-DCP PLUG

\$800

Includes (1) Cove unit with Plug infeed - Includes 72" Cord and 32" Infeed Jumper for 104" total cord infeed

ADDITIONAL LINKING UNITS

COV-DCL

\$575 EACH

Includes Linking Cove unit and Jumper up to 96", cable length determined by the top size

SPECIFICATIONS

- Size: 5.75" L x 2.5" W
- (2) 15 Amp Receptacles and (2) 2.1 Amp USB charging ports
- Surface Mount
- Max Daisy Chain - Hardwire - (9) units; Plug/Corded - (4) units
- Standard Silver Finish, Available in White or Black Finish upon request
- ETL Listed

AVAILABLE

- All Darran Collections



COVE CORDED SERIES

STYLE NUMBER	LIST PRICE
PD-COVE-PKO	\$800



SPECIFICATIONS

- Size 9.5”L x 2.5”W x 3.18”D
- (2) Power Receptacles, (2) 2.1 Amp USB charging ports and (1) Telecom Plate Knockout
- Surface Mount
- 108” Cord
- Standard Silver Finish, Available in White or Black Finish upon request
- ETL Listed

AVAILABLE



- All Darran Collections

TELECOM PLATES

THIS POD CAN HAVE UP TO 1 TOTAL PLATES

STYLE NUMBER	LIST PRICE
RJ45 (1)	\$35
RJ45 (2)	\$70
RJ45 (3)	\$105
USB (1)	\$70
USB (2)	\$140
RJ11/RJ45	\$70
RJ45/USB	\$105
RJ45/HDMI	\$190
HDMI/DVI	\$325
HDMI/USB	\$205
HDMI/VGA	\$240
VGA/MINI-STEREO	\$155
VGA/USB	\$175

PDFAA FLUSH DATA BAY ANODIZED ALUMINUM DOOR

	STYLE NUMBER	LIST PRICE
	PDFAA-H Hardwired	\$1195
	PDFAA-C Plug	\$1195
	PDFAA-DC Daisy Chain	\$1395

Features convenience plug on bottom - Max Daisy chain (4) units
 - Specify hardwired or plug for the first unit in series, daisy chained units will have a plug for connection through convenience plug.

SPECIFICATIONS

- Size 13.75"L x 6.375"W x 2.85"D
- (4) 15 Amp receptacles
- Surface Mount
- Standard Interior Black Finish
- Specify up to (4) Telecom Plates; (2) on side and (2) on bottom
- Corded units are UL Listed and CSA Certified. Hardwired Units are CSA Certified



AVAILABLE



- All Darran Collections
- Excludes Rail, Grove

TELECOM PLATES

THIS POD CAN HAVE UP TO 4 TOTAL PLATES

STYLE NUMBER	LIST PRICE
RJ45 (1)	\$35
RJ45 (2)	\$70
RJ45 (3)	\$105
USB (1)	\$70
USB (2)	\$140
RJ11/RJ45	\$70
RJ45/USB	\$105
RJ45/HDMI	\$190
HDMI/DVI	\$325
HDMI/USB	\$205
HDMI/VGA	\$240
VGA/MINI-STEREO	\$155
VGA/USB	\$175

PDFAF FLUSH DATA BAY FROSTED GLASS DOOR WITH DAISYLINK

	STYLE NUMBER	LIST PRICE
	PDFAF-H HARDWIRED	\$1095
	PDFAF-C PLUG	\$1095
	PDFAF-DC DAISY CHAIN	\$1295

Features convenience plug on bottom - Max Daisy chain (4) units
 - Specify hardwired or plug for the first unit in series, daisy chained units will have a plug for connection through convenience plug.



SPECIFICATIONS

- Size 13.75"L x 6.375"W x 2.85"D
- (4) 15 Amp receptacles
- Surface Mount
- Standard Interior Black Finish
- Specify up to (4) Telecom Plates; (2) on side and (2) on bottom
- Corded units are UL Listed and CSA Certified. Hardwired Units are CSA Certified

AVAILABLE

- All Darran Collections
- Excludes Rail, Grove



TELECOM PLATES

THIS POD CAN HAVE UP TO 4 TOTAL PLATES

STYLE NUMBER	LIST PRICE
RJ45 (1)	\$35
RJ45 (2)	\$70
RJ45 (3)	\$105
USB (1)	\$70
USB (2)	\$140
RJ11/RJ45	\$70
RJ45/USB	\$105
RJ45/HDMI	\$190
HDMI/DVI	\$325
HDMI/USB	\$205
HDMI/VGA	\$240
VGA/MINI-STEREO	\$155
VGA/USB	\$175

REEF POWER UNIT WITH DAISYLINK

STYLE NUMBER

LIST PRICE



REF310 PLUG

\$1100

SPECIFICATIONS

- Size 16.1”L x 6.25”W x 4.89”D
- (3) 120V Receptacles, (2) USB charging ports and (2) Knockouts for RJ45 Data Ports
- Surface Mount
- 108” Cord
- Features Convenience Plug on bottom of unit that allows for max (3) Daisy Chain
- Standard Black Finish, Available in White or Silver Finish upon request
- Additional Telecom Plate Knockout
- When used with Grove Tables an additional \$350 LIST will apply for the special cutout required.
- RJ45 for Knockouts not required. If not ordered a small hole will be present in this this location
- ETL Listed

AVAILABLE

- Grove
- Conferencing



TELECOM PLATES

THIS POD CAN HAVE UP TO 1 TOTAL PLATES

STYLE NUMBER	LIST PRICE
RJ45 (1)	\$35
RJ45 (2)	\$70
RJ45 (3)	\$105
USB (1)	\$70
USB (2)	\$140
RJ11/RJ45	\$70
RJ45/USB	\$105
RJ45/HDMI	\$190
HDMI/DVI	\$325
HDMI/USB	\$205
HDMI/VGA	\$240
VGA/MINI-STEREO	\$155
VGA/USB	\$175



SECLUSION CORDED POWER UNIT NON-LINKING

STYLE NUMBER

LIST PRICE



P2SECL

\$245

Choose from plate mount or clamp mount (seen in photo)

SPECIFICATIONS

- Size: 3.5"L x 2.2"D x 2.5"H
- (2) Power Receptacles
- Worksurface Clamp Mount or Plate Under Surface Mount
- Clamp Accessory accommodates table thickness up to 2"
- 72" Cord
- Standard Silver Finish, Black Finish available upon request
- UL/UCL Listed

AVAILABLE

- All Darran Collections



Clamp Mount

UDT POWER UNIT - NON-LINKING

STYLE NUMBER	LIST PRICE
UDT2/VD-SM PLUG Non-Linking	\$350

SPECIFICATIONS

- Size 6.5"L x 2.81"D x 1.26"H
- (2) Power receptacles and (1) Telecom Plate Cutout
- Side Mount, if Top Mount is required contact customer service
- 72" Cord
- Standard Black Powdercoat Finish
- Used in Apron Rails
- UL Listed

AVAILABLE

- Conferencing Apron Rails



TELECOM PLATES

THIS POD CAN HAVE UP TO 1 TOTAL PLATES

STYLE NUMBER	LIST PRICE
RJ45 (1)	\$35
RJ45 (2)	\$70
RJ45 (3)	\$105
USB (1)	\$70
USB (2)	\$140
RJ11/RJ45	\$70
RJ45/USB	\$105
RJ45/HDMI	\$190
HDMI/DVI	\$325
HDMI/USB	\$205
HDMI/VGA	\$240
VGA/MINI-STEREO	\$155
VGA/USB	\$175

VILLA POWER UNIT - NON-LINKING

STYLE NUMBER	LIST PRICE
 VIL-C PLUG Non-Linking	\$515

SPECIFICATIONS

- Size: Top Grommet 5.68"L X 3.39"W; Under Top 12"L x 3.13"W x 3.08"D
- (2) Power receptacles; (2) USB charging ports and (1) Knockouts for RJ45 Data Ports
- Surface Mount
- 72" Cord (Longer cord available, contact Customer Service)
- Standard Silver Finish, Black Finish available upon request
- UL or ETL Certified

AVAILABLE

- All Darran Collections
- Excludes Grove

RJ45 KNOCKOUT

STYLE NUMBER	LIST PRICE
RJ45 (1)	\$35



VILLA POWER UNIT WITH DAISYLINK

STYLE NUMBER LIST PRICE

STARTER UNITS



VIL-DCH HARDWIRED \$600
Includes (1) Villa unit with 120" Hardwire Infeed



VIL-DCP PLUG \$695
Includes (1) Villa with Plug Infeed - Includes 72" Cord and 32" Infeed Jumper for 104" total cord infeed

ADDITIONAL LINKING UNITS

VIL-DCL ADDITIONAL \$590
(Includes linking Villa and Jumper cable up to 96")



SPECIFICATIONS

- Size: Top Grommet 5.68" L X 3.39"W; Under Top 12"L x 3.13"W x 3.08"D
- (4) Power receptacles; (2) surface and (2) undersurface, (2) 2.1A USB charging ports and (1) Knockout for RJ45 Data Port
- Surface Mount
- Daisy Chain - Hardwire Max (10) Units, Plug/Corded Max (5) Units
- Standard Silver Finish, Black Finish available upon request
- UL or ETL Certified

AVAILABLE

- All Darran Collections
- Excludes Grove



RJ45 KNOCKOUT

STYLE NUMBER	LIST PRICE
RJ45 (1)	\$35